

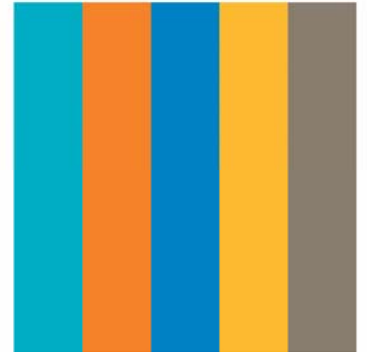

# SciLog<sup>®</sup> DINCon<sup>®</sup>, DINPres<sup>®</sup>, & DINTemp<sup>®</sup> Modules

Installation, Operating & Maintenance Instructions



ENGINEERING YOUR SUCCESS.

---

SciLog® and DINCon®, DINPres®, and DINTemp®, are registered trademarks of Parker Hannifin Corporation.

Parker Hannifin Corporation has a continuous policy of product development and although the Company reserves the right to change specification, it attempts to keep customers informed of any alterations. This publication is for general information only and customers are requested to contact your local Parker Sales Representative for detailed information and advice on a product's suitability for specific applications. All products are sold subject to the company's Standard conditions of sale.

---

# Contents

Introduction .....6

Calibration .....6

Warranty .....7

Standards .....7

Installation & Start-Up.....7

Maintenance & Cleaning.....7

DIN Module Specifications.....8

Sensor Specifications .....9

SciCon Sensors .....9

SciPres Sensors .....9

SciTemp Sensors .....10

Installation .....11

Operating Instructions.....14

Modbus Register List.....16

DINCon Registers.....16

DINPres Registers .....20

DINTemp Registers .....25

Reference Information .....29

# Precautions

READ this manual BEFORE operating or servicing this equipment.

FOLLOW these instructions carefully.

SAVE this manual for future reference.

DO NOT allow untrained personnel to operate, clean, inspect, service or tamper with this equipment.

ALWAYS DISCONNECT this equipment from the power source before cleaning or performing maintenance.

Contact your local Parker Division for parts, information and service.

	<p style="text-align: center;"><b>! WARNING</b></p> <p>DISCONNECT ALL POWER TO THIS UNIT BEFORE INSTALLING, SERVICING, CLEANING OR REMOVING THE FUSE. FAILURE TO DO SO COULD RESULT IN BODILY HARM AND/OR PROPERTY DAMAGE.</p>
	<p style="text-align: center;"><b>! CAUTION</b></p> <p>OBSERVE PRECAUTIONS FOR HANDLING ELECTROSTATIC SENSITIVE DEVICES.</p>
	<p style="text-align: center;"><b>! WARNING</b></p> <p>ONLY PERMIT QUALIFIED PERSONNEL TO SERVICE THIS EQUIPMENT. EXERCISE CARE WHEN MAKING CHECKS, TEST AND ADJUSTMENTS THAT MUST BE MADE WITH POWER ON. FAILING TO OBSERVE THESE PRECAUTIONS CAN RESULT IN BODILY HARM.</p>
	<p style="text-align: center;"><b>! WARNING</b></p> <p>FOR CONTINUED PROTECTION AGAINST SHOCK HAZARD, CONNECT TO PROPERLY GROUNDED OUTLET ONLY. DO NOT REMOVE THE GROUND PRONG.</p>
	<p style="text-align: center;"><b>! CAUTION</b></p> <p>USE ONLY CLASS 2 LISTED EXTERNAL 24 VDC POWER SUPPLY WITH THESE DEVICES.</p>

# Précautions

LISEZ ce manuel AVANT de faire fonctionner ou d'entretenir cet équipement.





SUIVEZ attentivement ces instructions.

CONSERVEZ ce manuel pour future référence.

NE LAISSEZ PAS du personnel non qualifié utiliser, nettoyer, inspecter, entretenir, réparer ou manipuler cet équipement.

DÉBRANCHEZ TOUJOURS cet équipement de la source de courant avant de nettoyer ou d'exécuter l'entretien.

APPELEZ PARKER pour pièces détachées, renseignements et entretien.

	<p style="text-align: center;"><b>! ATTENTION</b></p> <p>DÉBRANCHEZ TOUT COURANT DE CETTE UNITÉ AVANT DE FAIRE L'INSTALLATION, D'EFFECTUER L'ENTRETIEN, LE NETTOYAGE OU AVANT DE RETIRER LE FUSIBLE. NE PAS OBSERVER CES PRÉCAUTIONS RISQUERAIT DE CAUSER DES BLESSURES CORPORELLES OU/ET D'ENDOMMAGER L'ÉQUIPEMENT.</p>
	<p style="text-align: center;"><b>! PRUDENCE</b></p> <p>SOYEZ PRUDENT LORSQUE VOUS MANIPULEZ DES APPAREILS SENSIBLES À L'ÉLECTROSTATIQUE.</p>
	<p style="text-align: center;"><b>! ATTENTION</b></p> <p>ONLY PERMIT QUALIFIED PERSONNEL TO SERVICE THIS EQUIPMENT. EXERCISE CARE WHEN MAKING CHECKS, TEST AND ADJUSTMENTS THAT MUST BE MADE WITH POWER ON. FAILING TO OBSERVE THESE PRECAUTIONS CAN RESULT IN BODILY HARM.</p>
	<p style="text-align: center;"><b>! ATTENTION</b></p> <p>POUR ASSURER UNE PROTECTION CONTINUE CONTRE UNE DÉCHARGE ÉLECTRIQUE, BRANCHEZ UNIQUEMENT SUR UNE PRISE CORRECTEMENT RELIÉE À LA TERRE. NE RETIREZ PAS LA FICHE DE TERRE.</p>
	<p style="text-align: center;"><b>! PRUDENCE</b></p> <p>N'UTILISER QUE DE L'ALIMENTATION ÉLECTRIQUE 24 VDC EXCLUSIVE DE CLASSE 2 AVEC CES DISPOSITIFS.</p>

---

## Introduction

You will find the SciLog® DINCon, DINPres and DINTemp Modules and sensors easy to use. The state-of-the-art hardware and software design of the SciLog® DIN Module and sensor combination allows you to measure and document the conductivity, pressure or temperature of many filtration / separation processes. With proper maintenance, the SciLog® DIN Modules will provide many years of excellent service and performance.



Please read the following instructions carefully!

**Inspections:** Remove the products carefully from the shipping container. Check the contents against the purchase order to verify that all parts are included and undamaged.

Please do the inspection now, even if the products are not used immediately. Many carriers must receive damage claims within seven days of delivery. Please retain all packing material so unit may be shipped safely, if necessary.

**Customer Service:** Parker Bioscience customer service: If assistance is required, please contact us at:

Parker Hannifin Corporation  
Bioscience & Water Filtration  
2340 Eastman Avenue  
Oxnard, California, USA 93030  
toll free: 877 784 2234  
phone: +1 805 604 3400  
fax: +1 805 604 3401  
email: [dhpsales.na@parker.com](mailto:dhpsales.na@parker.com)  
[www.parker.com/dhsingleuse](http://www.parker.com/dhsingleuse)

Parker Hannifin Manufacturing Ltd  
Bioscience Engineering Filtration  
Durham Road  
Birtley, Co. Durham  
DH3 2SF, England  
phone +44 (0)191 4105121  
fax +44 (0)191 4105312  
email: [dhprocess@parker.com](mailto:dhprocess@parker.com)  
[www.parker.com/dhsingleuse](http://www.parker.com/dhsingleuse)

Parker customer service personnel will be able to serve you more efficiently if you have the following information:

- Serial number and model name of the equipment
- Installation procedure being used
- Concise list of symptoms
- List of operating procedures and conditions in use when problem arose

## Calibration

The SciLog® DIN Modules are calibrated devices, and are calibrated with test equipment that is traceable to SI through NIST.

A Calibration Certificate is included with each unit, and has a one year expiration date.

It is highly recommended that the Module be calibrated on an annual basis or more often if your Metrology Department deems it necessary.

Parker Bioscience provides this Calibration Service, complete with a new certificate, showing the “as found” and “as left” data.

Contact your local Parker Bioscience representative.

# Warranty

Country specific information can be found at: [www.parker.com/termsandconditions](http://www.parker.com/termsandconditions)

## Standards

EN 61326-1:2006, Class B

EN 61010-1:2010 Ed.3+ C1; C2

Conforms to UL STD 61010-1:2012 Ed.3+ R: 29Apr2016

Certified to CSA STD C22.2 No 61010-1-12:2012 Ed.3+U1;U2



**Caution:** The maximum recommended pressure for the sensors is 60 psi.  
If this is exceeded, problems with leakage and functionality can occur.

## Installation & Start Up

Installation of the SciLog® DINCon® DINPres®, and DINTemp® Modules must be carried out only by trained personnel in accordance with the relevant regulations and this operations manual.

Make sure that the technical specifications and input ratings of the SciLog® sensors are observed. See the appropriate Sensor Specifications page.

The protection provided by this equipment may be impaired if the SciLog® sensors are used in a manner inconsistent with this manual or for purposes not specified by the manufacturer.

## Maintenance & Cleaning

The SciLog® DIN Modules are maintenance free. The single-use SciLog® sensors come pre-calibrated from the factory and require no maintenance.

To remove dust, dirt and stains, the outer surfaces of the DIN Modules may be wiped using a soft, non-fluffing cloth moistened with water. If required, you may also use a mild detergent or 2-propanol.

The single-use sensors may be sanitized with 0.1 Molar NaOH, or 2-propanol. They may be autoclaved up to 2 times, or gamma-irradiated with exposure up to 45 kGy.

# Hardware

## Specifications – All Modules

<b>Dimensions</b>		W: 0.875" (2.2 cm); Height 4.0" (10.2 cm); D: 4.75" (12.1 cm)
<b>Weight</b>		0.3 lb. (0.14 Kg)
<b>Enclosure</b>		Molded Plastic
<b>Electrical</b>	<b>Power</b>	24 VDC, 250 mA. Use only Class 2 External Power Supply
	<b>Battery</b>	CR1632, used for internal clock, not user serviceable
	<b>I/O Port Top</b>	8 pin Terminal Block, numbered from rear:
		1: +24 VDC 2: 24 VDC Return 3: N/C 4: Signal GND (COM) 5: RS-232 RX 6: RS-232 TX 7: RS-485 A 8: RS-485 B
	<b>I/O Port – 2</b>	RJ45, Ethernet Connection
	<b>I/O Port - 3</b>	USB Connection
	<b>I/O Port Bottom</b>	8 Pin Sensor Connection, DINCon has 1, DINPres and DINTemp have 3.
<b>Software</b>	<b>DISPLAY</b>	Power Status LED, Sensor Status LED's
	<b>Modbus</b>	Modbus RTU via RS-232 Modbus RTU via RS-485
		Modbus RTU via USB Modbus TCP via Ethernet
<b>Environmental</b>	<b>Temperature</b>	4 – 60° C
	<b>Altitude</b>	Up to 2000 Meters
	<b>IP Rating</b>	IP20, Indoor dry environments, unit is wipe-down only
	<b>Rel. Humidity</b>	0 – 95%
	<b>Voltage</b>	Fluctuation allowed: +/- 10%
	<b>Pollution</b>	Degree: 2



## Specifications – Sensors

### SciCon:

Power	5 VDC provided by DINCon® Module
Fluid Connections	Choice of five sizes: Luer, 3/8" Barb, 1/2" Barb, 3/4" Tri-Clover (TC) Sanitary and 1" Tri-Clover ('Ladish') Sanitary.
Wetted Materials	Polysulphone meets USP Class VI and FDA 21 CFR 177.1520, all wetted materials made with animal-free compounds.
Sensor Type	4-Electrode Conductivity Cell, gold plated pins.
Conductivity Range	1 µS/cm to 200 mS/cm; Resolution: 0.1 µS/cm.
Accuracy	High: ± 0.25 mS in the 0.1 - 200 mS range; Low: ± 3 µS in the 0 - 100 µS range
Temperature Range	4-50° C
Temperature Accuracy	+/- 0.5° C
Temperature Probe	Thermistor
Pre-Calibration	0.10 M KCl Solution, 12.88 mS at 25.0° C
Sensor Microchip	EPROM, Stores Sensor ID, and Calibration Factor.
Sensor Connector & Cables	Lockable and Waterproof.

### SciPres:

Power	5 VDC provided by DINPres® Module
Fluid Connections	Choice of five sizes: Luer, 3/8" Barb, 1/2" Barb, 3/4" Tri-Clover (TC) Sanitary and 1" Tri-Clover ('Ladish') Sanitary.
Wetted Materials	Polysulphone meets USP Class VI and FDA 21 CFR 177.1520, all wetted materials made with animal-free compounds.
Sensor Type	Medical grade, silicone piezoresistive sensing element with on-chip temperature compensation.
Sensor Isolation	Insoluble silicone dielectric gel isolates sensing element from process solution. The gel is a non-toxic, non-allergenic elastomeric system.
Pressure Range	-5 to 60 psi (-0.34 to 4.14 bar).

<b>Accuracy</b>	+/- 0.30 psi at -5 to 30 psi for 2 point calibrated sensors (can be improved to -5 to 60 psi with 3 point calibration, also available)
<b>Resolution</b>	0.01 psi
<b>Temperature Range</b>	0 to 60 °C (32 to 140 °F).
<b>Sensor Microchip</b>	EPROM, Stores Sensor ID, and Calibration Factor.
<b>Sensor Connector &amp; Cables</b>	Lockable and Waterproof.

## SciTemp:

<b>Power</b>	5 VDC provided by DINTemp® Module
<b>Fluid Connections</b>	Choice of five sizes: Luer, 3/8" Barb, 1/2" Barb, 3/4" Tri-Clover (TC) Sanitary and 1" Tri-Clover ('Ladish') Sanitary.
<b>Wetted Materials</b>	Polysulphone meets USP Class VI and FDA 21 CFR 177.1520, all wetted materials made with animal-free compounds.
<b>Sensor Type</b>	Thermistor, Epoxy coated, 2252 Ω
<b>Temperature Range</b>	-40 to +150° Celsius
<b>Accuracy</b>	+/- 0.10° Celsius in the 4.0 to 70° Celsius range.
<b>Resolution</b>	0.01 ° Celsius
<b>Sensor Microchip</b>	EPROM, Stores Sensor ID, and Calibration Factor.
<b>Sensor Connector &amp; Cables</b>	Lockable and Waterproof.

---

# Installation:

## Overview:

The DINCon, DINPres, and DINTemp Modules are designed to be installed as part of a control system inside a control cabinet that has a 24 VDC source available and has Modbus communication protocol capability.

The DIN Modules are installed on standard DIN rail. They are usually mounted with the red locking tab located at the bottom of the unit. This places the Power and Communication connections at the top of the Module and the Sensor connections at the bottom.

## Wiring Power and Communication:

Connect 24 Volts DC, 250 mA power to Pins 1 (+) and 2 (-) of the 8 pin terminal block. (Note - pin 1 is at the rear.)

All data acquisition is via Modbus registers in either RTU or ASCII. The available physical layers are RS-232, RS-485, Ethernet and USB. The recommended physical layer for installation of *multiple units* is Modbus/RTU over RS-485 with Modbus/TCP via Ethernet a close second.

For RS-232, connect to the following: Pin 4 = Signal Ground, Pin 5 = RX, Pin 6 = TX.

For RS-485, connect to the following: Pin 4 = Signal Ground, Pin 7 = B, Pin 8 = A.

For Ethernet connect an Ethernet cable to the provided RJ45 jack.

For USB connect to the provided USB Type A jack.

DIN Rail

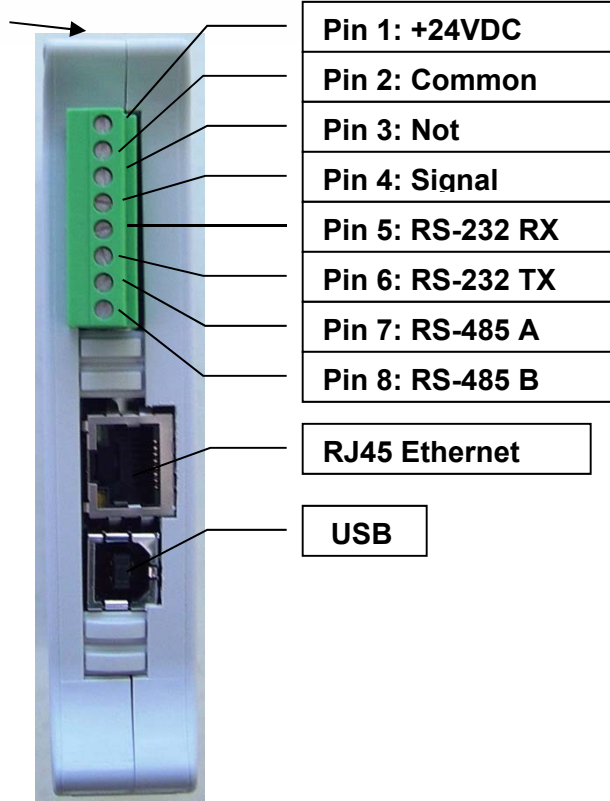

## Connecting Sensors:

All Sensors, SciCon for use with the DINCon Module, SciPres for use with the DINPres Module and SciTemp for use with the DINTemp Module are disposable flow through sensors that are purchased separately from Parker and come Pre-Calibrated.

The Sensors connect to a provided cable that has a watertight connector on the sensor end and an 8 pin connector on the other end that plugs into a matching port on the bottom of the Module. The DINCon has only one port, and uses only one SciCon Sensor. The DINPres and DINTemp have 3 ports, can support up to 3 SciPres or SciTemp Sensors, and they are referred to as P1 – P3 or T1 – T3 beginning with P1 and T1 at the rear, or the closest connector to the DIN rail.

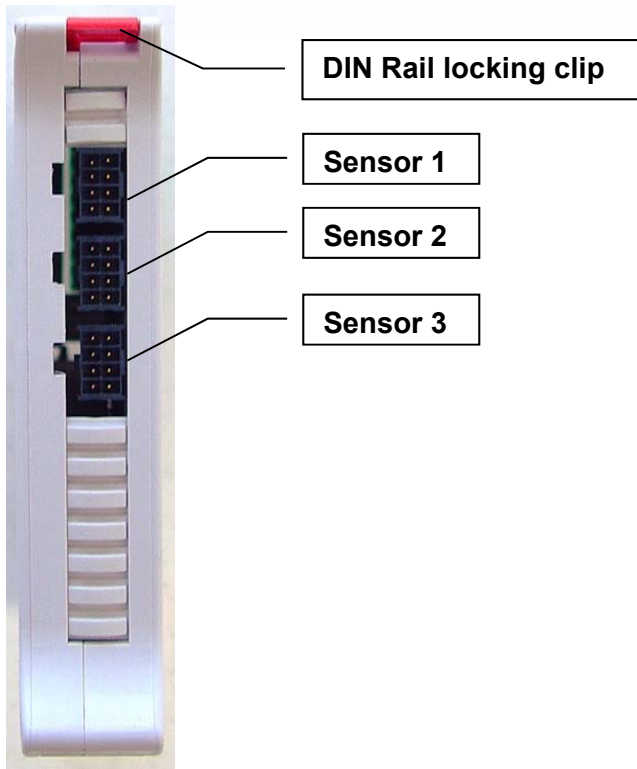

When powered up and connected the Sensor Status LEDs on the front of the Module are colored as follows:

- Green = Connected
- Red = Disconnected
- Yellow = Connected but not calibrated.

If the LED shows Yellow, it's time to replace the affected Sensor with a new one. Connecting the wrong type of Sensor to the module also results in a Yellow indication.

# Operating Instructions:

## Modbus Overview:

The Parker DIN modules communicate via the Modbus protocol. All data is transferred using the Modbus holding registers. The default connection is RS-485 at 115,200 baud, 8 bits, even parity and one stop bit.



**Note:** If parity setting (register 109) is changed to “none” then two stop bits must be used.

The default Modbus mode is RTU. The Default Modbus addresses (register 105) for the various Modules are:

DINCon: 10

DINPres: 20

DINTemp: 30

Four physical layer interfaces are available for DIN Module communications:

RS232 – Modbus/RTU or Modbus/ASCII

RS485 – Modbus/RTU or Modbus/ASCII

Ethernet - Modbus/TCP

USB - Modbus/RTU or Modbus/ASCII

The active Modbus interface is selected by connecting to the modules built-in web server. Connect using an Ethernet patch cable and a hub on your network, or directly to the unit with an Ethernet crossover cable. The default IP addresses are 192.168.0.142 for the DINCon, 192.168.0.143 for the DINPres, and 192.168.0.144 for the DINTemp. It may be necessary to create a new connection, or modify an existing one. Make any changes required to configuration and click on “Submit” to save them to the module.

Network IP Address	
IP Address	192 .168 .000 .143
IP Subnet Mask	255 .255 .255 .000
IP Gateway	192 .168 .000 .001

Modbus Settings	
Communication Mode (0=485R, 1=485A, 2=232R, 3=232A, 4=USBR, 5=USBA, 6=TCP)	0
Modbus TCP Port	000502
Modbus RTU/ASCII Address	20
Baud Rate (0=1200, 1=2400, 2=4800, 3=9600, 4=19.2K, 5=28.8K, 6=38.4K, 7=57.6K, 8=115.2K)	8
Word Length	8
Parity (0=none, 1=odd, 2=even)	2

Any changes made via this interface require a power cycle of the module to take effect.

---

Modbus register definitions are listed below for each type – DINCon, DINPres, and DINTemp.

For floating point values the DIN modules use the standard IEEE-754 format.

The Modbus address and communication parameters for a module can be changed by writing to registers 104-109 as a block (at the same time).

The Modules contain a Real Time Clock that will be set to the current date and the end users time zone prior to shipment from Parker. If re-setting the Real Time Clock is needed, the data must also be written in one continuous Modbus multi-register write operation to registers 130-137.

The DINPres Module has a selectable Data Refresh Rate, with the default of 13 milliseconds being raw data. (Register 143) If the default setting is not used, a conditioned signal is provided.

The Sensors have individual ID numbers and calibration information stored in, and printed on them. Values relating to the ID numbers can be found in registers 201-206 for Sensor 1, 241-246 for Sensor 2 and 281-286 for Sensor 3. (Note: The first letter of this ID number, a “C”, “S” or “T”, is not in any of the registers.)

## Units and Alarm Limits:

The Modules provide the ability to set the desired Units for the outputs, as well as appropriate High and Low Alarm Limits. The alarms are absolute and not dependent upon signal direction. (i.e. The signal does not have to be above the low alarm limit value first to trip it.) The register list in section C below lists the available units for each Module. All Alarm Limits default to 0.0 and are thereby initially disabled.

### DINCon:

Conductivity Units:	Default: $\mu$ S	Register 140
Temperature Units:	Default: $^{\circ}$ C	Register 143
Conductivity Limits:	Low:	Registers 160-161
	High:	Registers 162-163
Temperature Limits:	Low:	Registers 164-165
	High:	Registers 166-167

### DINPres:

Pressure Units:	Default: psi	Register 140
P1 Pressure Limits:	Low:	Registers 160-161
	High:	Registers 162-163
P2 Pressure Limits:	Low:	Registers 164-165
	High:	Registers 166-167
P3 Pressure Limits:	Low:	Registers 168-169
	High:	Registers 170-171

DINTemp:		
Temperature Units:	Default: °C	Register 140
T1 Temperature Limits:	Low:	Registers 160-161
	High:	Registers 162-163
T2 Temperature Limits:	Low:	Registers 164-165
	High:	Registers 166-167
T3 Temperature Limits:	Low:	Registers 168-169
	High:	Registers 170-171

## Hardware Calibration:

The factory hardware calibration data is available as read only values and is only performed on new modules with a special test fixture at the time of manufacture.

## User Calibration of the Sensors:

If User Custom Calibration of a Sensor is desired, it can be accomplished by adjusting the Cal Concentration, Cal Temperature or Cal Pressure values, and setting the proper Start Bit in the appropriate User Cal Status Register.

Custom Calibration of SciPres and SciTemp Sensors is rare, and it is only recommended on the SciCon Sensors if a much lower Cal Concentration is desired. (12.88 mS is standard, and functions with satisfactory results.)

## Factory Calibration of SciPres Sensors:

The DINPres reads and utilizes calibration data from SciPres Sensors that have been calibrated to two points, 0 and 30 psi, or three points, 0, 54 and 6 psi depending upon the type of stock purchased. It has also been equipped a Max Pressure Watchdog feature.

The Max Pressure Watchdog feature records in the sensor's memory the maximum pressure seen by the sensor while it is connected to the DINPres. The maximum recommended pressure for the sensors is 60 psi. If this is exceeded, problems with leakage and functionality can occur. This value is available in the appropriate register; see the list in the next section.

**Please Note:** If the company Metrology Department tests the Sensors using a regulated air source, care must be taken to avoid hi inrush pressure. Much like inrush current in electronics, if the valve to the regulator is opened too fast, this can expose the Sensor to higher pressures than the regulator is set for. This will be reflected in the Max Pressure value, and may risk damage to the sensor if this is done near the 54 psi calibration point or above. existing factory two or three point calibration. This can be reset or cleared if desired.



# Modbus Register List:

## DINCon Register List:

ADDRESS	ACCESS	FORMAT	VALUE	Default
90-99	R	ASCII String	DINCon Serial Number	
100	R	16 bit	Model Number	<b>0</b>
			0 = DINCon	
101-102	R	IEEE Float	Software Version	
103	R/W	16 bit	Reset Control	
			bit 0 = System Reset	
			bit 1 = Reset to Defaults	
			bit 2 = Alarm Reset	
104-105	R/W	16 bit	Modbus Address	
			104 must be set to 0xa55a (hex)	<b>0xa55a</b>
			<b>registers 104-109 must be written as a block</b>	
			105 contains Modbus address	<b>10</b>
106	R/W	16 bit	Modbus Mode	<b>0</b>
			0 = RS485 RTU	
			1 = RS485 ASCII	
			2 = RS232 RTU	
			3 = RS232 ASCII	
			4 = USB RTU	
			5 = USB ASCII	
			6 = TCP	
107	R/W	16 bit	Modbus Baud Rate (115200 default)	<b>8</b>
			0 = 1200	
			1 = 2400	
			2 = 4800	
			3 = 9600	
			4 = 19200	
			5 = 28800	
			6 = 38400	
			7 = 57600	
			8 = 115200	
108	R/W	16 bit	Modbus Serial Word Length ( 7 or 8)	<b>8</b>
109	R/W	16 bit	Modbus Serial Parity (Even, 1 Stop Bit default)	<b>2</b>
			0 = none, 2 Stop Bits	
			1 = odd, 1 Stop Bit	
			2 = even, 1 Stop Bit	
110	R/W	16 bit	TCP Address P1	<b>192</b>
111			TCP Address P2	<b>168</b>

112			TCP Address P3	<b>0</b>
113			TCP Address P4	<b>142</b>
114	R/W	16 bit	TCP Mask P1	<b>255</b>
115			TCP Mask P2	<b>255</b>
116			TCP Mask P3	<b>255</b>
117			TCP Mask P4	<b>0</b>
118	R/W	16 bit	TCP Gateway P1	<b>192</b>
119			TCP Gateway P2	<b>168</b>
120			TCP Gateway P3	<b>0</b>
121			TCP Gateway P4	<b>1</b>
130	R/W	16 bit	RTCC Control	
			bit0: Set Clock Values	
			<b>Registers 130-137 must be written as a block</b>	
131	R/W	16 bit	Day of Week (1-7)	
132	R/W	16 bit	Month	
133	R/W	16 bit	Day	
134	R/W	16 bit	Year	
135	R/W	16 bit	Hour (24)	
136	R/W	16 bit	Minute	
137	R/W	16 bit	Second	
140	R/W	16 bit	Conductivity Units	<b>0</b>
			0 = uS	
			1 = mS	
			2 = ppm KCl	
			3 = ppm NaCl	
			4 = ppm 442	
141-142	R/W	IEEE Float	Cal Concentration (default 12.88mS) (Only change for use with a Custom Calibration)	<b>12.88</b>
143	R/W	16 bit	Temperature Units	<b>0</b>
			0 = C	
			1 = F	
144-145	R/W	IEEE Float	Cal Temperature (default 25.0C) (Only change for use with a Custom Calibration)	<b>25.0</b>
150	R	16 bit	Conductivity Status	
			bit0 = disconnected	
			bit1 = uncalibrated	
			bit2 = low alarm	
			bit3 = high alarm	
151-152	R	IEEE Float	Conductivity Value	
153	R	16 bit	Temperature Status	
			bit0 = disconnected	
			bit1 = uncalibrated	
			bit2 = low alarm	

			bit3 = high alarm	
154-155	R	IEEE Float	Temperature Value	
160-161	R/W	IEEE Float	Conductivity Alarm Limit - Low	<b>0.0</b>
162-163	R/W	IEEE Float	Conductivity Alarm Limit - High	<b>0.0</b>
164-165	R/W	IEEE Float	Temperature Alarm Limit - Low	<b>0.0</b>
166-167	R/W	IEEE Float	Temperature Alarm Limit - High	<b>0.0</b>
180	R/W	IEEE Float	Temperature Reference	<b>25.0</b>
182	R/W	IEEE Float	Temperature Coefficient	<b>1.90</b>
184	R/W	IEEE Float	Temperature Offset	
186	R/W	16 bit	Temperature Comp. Disabled if NZ	<b>0.0</b>
201	R/W	16 bit	Sensor ID Type	
			0 = Luer	
			1 = 3/8" Barb	
			2 = 1/2" Barb	
			3 = 3/4" TC	
			4 = 1" TC	
			100 = Cal Fixture	
202	R/W	16 bit	Sensor ID Material	
			0 = Polypropylene	
			1 = Polysulfone	
203	R/W	16 bit	Sensor ID Month	
204	R/W	16 bit	Sensor ID Year	
205	R/W	16 bit	Sensor ID Lot	
206	R/W	16 bit	Sensor ID Unit Number	
208	R/W	IEEE Float	Sensor Temperature Offset (TO)	
210	R/W	IEEE Float	Sensor Cal Factor (CCF)	
220	R/W	16 bit	Sensor Custom Cal Status	
			bit 0 = Invalid	
			bit 2 = Start Cal	
			bit 6 = Cal in Progress	
			bit 7 = Write Cal Data	
221	R/W	IEEE Float	Sensor Custom Temperature Offset (CTO)	
223	R/W	IEEE Float	Sensor Custom Cal Factor (CCF)	

## DINPres Register List:

ADDRESS	ACCESS	FORMAT	VALUE	DEFAULT
90-99	R	ASCII String	DINPres Serial Number	
100	R	16 bit	Model Number	<b>1</b>
			1 = DINPres	
101-102	R	IEEE Float	Software Version	
103	R/W	16 bit	Reset Control	
			bit 0 = System Reset	
			bit 1 = Reset to Defaults	
			bit 2 = Alarm Reset	
104-105	R/W	16 bit	Modbus Address	
			104 must be set to 0xa55a	<b>0xa55a</b>
			<b>registers 104-109 must be written as a block</b>	
			105 contains Modbus address	<b>20</b>
106	R/W	16 bit	Modbus Mode	<b>0</b>
			0 = RS485 RTU	
			1 = RS485 ASCII	
			2 = RS232 RTU	
			3 = RS232 ASCII	
			4 = USB RTU	
			5 = USB ASCII	
			6 = TCP	
107	R/W	16 bit	Modbus Baud Rate (115200 Default)	<b>8</b>
			0 = 1200	
			1 = 2400	
			2 = 4800	
			3 = 9600	
			4 = 19200	
			5 = 28800	
			6 = 38400	
			7 = 57600	
			8 = 115200	
108	R/W	16 bit	Modbus Serial Word Length (7 or 8)	<b>8</b>
109	R/W	16 bit	Modbus Serial Parity (Even, 1 Stop Bit default)	<b>2</b>
			0 = none, 2 Stop Bits	
			1 = odd, 1 Stop Bit	
			2 = even, 1 Stop Bit	
110	R/W	16 bit	TCP Address P1	<b>192</b>
111			TCP Address P2	<b>168</b>
112			TCP Address P3	<b>0</b>
113			TCP Address P4	<b>143</b>

114	R/W	16 bit	TCP Mask P1	<b>255</b>
115			TCP Mask P2	<b>255</b>
116			TCP Mask P3	<b>255</b>
117			TCP Mask P4	<b>0</b>
118	R/W	16 bit	TCP Gateway P1	<b>192</b>
119			TCP Gateway P2	<b>168</b>
120			TCP Gateway P3	<b>0</b>
121			TCP Gateway P4	<b>1</b>
130	R/W	16 bit	RTCC Control	
			bit0: Set Clock Values	
			<b>Registers 130-137 must be written as a block</b>	
131	R/W	16 bit	Day of Week (1-7)	
132	R/W	16 bit	Month	
133	R/W	16 bit	Day	
134	R/W	16 bit	Year	
135	R/W	16 bit	Hour (24)	
136	R/W	16 bit	Minute	
137	R/W	16 bit	Second	
140	R/W	16 bit	Pressure Units	<b>0</b>
			0 = psi	
			1 = kPa	
			2 = bar	
			3 = mmHg	
141-142	R/W	IEEE Float	Cal Pressure (Default 30psi) (Only change for use with a Custom Calibration)	<b>30.0</b>
143	R/W	16 bit	Data Refresh Rate	<b>0</b>
			0 = 13 milliseconds	
			1 = 25 ms	
			2 = 50 ms	
			3 = 125 ms	
			4 = 250 ms	
			5 = 350 ms	
			6 = 500 ms	
			7 = 750 ms	
			8 = 1 second	
			9 = 1.5 seconds	
			10 = 2 seconds	
			11 = 4 seconds	
150	R	16 bit	P1 Status	
			bit 0 = Disconnected	
			bit 1 = Uncalibrated	
			bit 2 = Low Alarm	

			bit 3 = High Alarm	
151-152	R	IEEE Float	P1 Pressure Value	
153	R	16 bit	P2 Status	
			bit 0 = Disconnected	
			bit 1 = Uncalibrated	
			bit 2 = Low Alarm	
			bit 3 = High Alarm	
154-155	R	IEEE Float	P2 Pressure Value	
156	R	16 bit	P3 Status	
			bit 0 = Disconnected	
			bit 1 = Uncalibrated	
			bit 2 = Low Alarm	
			bit 3 = High Alarm	
157-158	R	IEEE Float	P3 Pressure Value	
160-161	R/W	IEEE Float	P1 Pressure Alarm Limit - Low	<b>0.0</b>
162-163	R/W	IEEE Float	P1 Pressure Alarm Limit - High	<b>0.0</b>
164-165	R/W	IEEE Float	P2 Pressure Alarm Limit - Low	<b>0.0</b>
166-167	R/W	IEEE Float	P2 Pressure Alarm Limit - High	<b>0.0</b>
168-169	R/W	IEEE Float	P3 Pressure Alarm Limit - Low	<b>0.0</b>
170-171	R/W	IEEE Float	P3 Pressure Alarm Limit - High	<b>0.0</b>
201	R/W	16 bit	P1 Sensor ID Type	
			0 = Luer	
			1 = 3/8" Barb	
			2 = 1/2" Barb	
			3 = 3/4" TC	
			4 = 1" TC	
			100 = Cal Fixture	
202	R/W	16 bit	P1 Sensor ID Material	
			0 = Polypropylene	
			1 = Polysulfone	
203	R/W	16 bit	P1 Sensor ID Month	
204	R/W	16 bit	P1 Sensor ID Year	
205	R/W	16 bit	P1 Sensor ID Lot	
206	R/W	16 bit	P1 Sensor ID Unit Number	
208	R/W	IEEE Float	P1 Sensor Pressure Offset (PZ)	
210	R/W	IEEE Float	P1 Sensor Cal Factor (CF)	
212	R/W	IEEE Float	P1 Sensor Cal Pressure (CP1)	
214	R/W	IEEE Float	P1 Sensor Cal Factor 2 (CF2)	
216	R/W	IEEE Float	P1 Sensor Cal Pressure 2 (CP2)	
220	R/W	16 bit	P1 Sensor Custom Cal Status	
			bit 0 = Invalid	
			bit 1 = Start Zero	

			bit 2 = Start Span	
			bit 6 = Cal in Progress	
			bit 7 = Write Cal Data	
221	R/W	IEEE Float	P1 Sensor Custom Pressure Offset (CPZ)	
223	R/W	IEEE Float	P1 Sensor Custom Cal Factor (CCF)	
235	R/W	IEEE Float	P1 Sensor Max Pressure	
237	R/W	16 bit	P1 Sensor MaxP, Day	
238	R/W	16 bit	P1 Sensor MaxP, Month	
239	R/W	16 bit	P1 Sensor MaxP, Year	
241	R/W	16 bit	P2 Sensor ID Type	
			0 = Luer	
			1 = 3/8" Barb	
			2 = 1/2" Barb	
			3 = 3/4" TC	
			4 = 1" TC	
			100 = Cal Fixture	
242	R/W	16 bit	P2 Sensor ID Material	
			0 = Polypropylene	
			1 = Polysulfone	
243	R/W	16 bit	P2 Sensor ID Month	
244	R/W	16 bit	P2 Sensor ID Year	
245	R/W	16 bit	P2 Sensor ID Lot	
246	R/W	16 bit	P2 Sensor ID Unit Number	
248	R/W	IEEE Float	P2 Sensor Pressure Offset (PZ)	
250	R/W	IEEE Float	P2 Sensor Cal Factor (CF)	
252	R/W	IEEE Float	P2 Sensor Cal Pressure (CP1)	
254	R/W	IEEE Float	P2 Sensor Cal Factor 2 (CF2)	
256	R/W	IEEE Float	P2 Sensor Cal Pressure 2 (CP2)	
260	R/W	16 bit	P2 Sensor Custom Cal Status	
			bit 0 = Invalid	
			bit 1 = Start Zero	
			bit 2 = Start Span	
			bit 6 = Cal in Progress	
			bit 7 = Write Cal Data	
261	R/W	IEEE Float	P2 Sensor Custom Pressure Offset (CPZ)	
263	R/W	IEEE Float	P2 Sensor Custom Cal Factor (CCF)	
275	R/W	IEEE Float	P2 Sensor Max Pressure	
277	R/W	16 bit	P2 Sensor MaxP, Day	
278	R/W	16 bit	P2 Sensor MaxP, Month	
279	R/W	16 bit	P2 Sensor MaxP, Year	
281	R/W	16 bit	P3 Sensor ID Type	
			0 = Luer	

			1 = 3/8" Barb	
			2 = 1/2" Barb	
			3 = 3/4" TC	
			4 = 1" TC	
			100 = Cal Fixture	
282	R/W	16 bit	P3 Sensor ID Material	
			0 = Polypropylene	
			1 = Polysulfone	
283	R/W	16 bit	P3 Sensor ID Month	
284	R/W	16 bit	P3 Sensor ID Year	
285	R/W	16 bit	P3 Sensor ID Lot	
286	R/W	16 bit	P3 Sensor ID Unit Number	
288	R/W	IEEE Float	P3 Sensor Pressure Offset (PZ)	
290	R/W	IEEE Float	P3 Sensor Cal Factor (CF)	
292	R/W	IEEE Float	P3 Sensor Cal Pressure (CP1)	
294	R/W	IEEE Float	P3 Sensor Cal Factor 2 (CF2)	
296	R/W	IEEE Float	P3 Sensor Cal Pressure 2 (CP2)	
300	R/W	16 bit	P3 Sensor Custom Cal Status	
			bit 0 = Invalid	
			bit 1 = Start Zero	
			bit 2 = Start Span	
			bit 6 = Cal in Progress	
			bit 7 = Write Cal Data	
301	R/W	IEEE Float	P3 Sensor Custom Pressure Offset (CPZ)	
303	R/W	IEEE Float	P3 Sensor Custom Cal Factor (CCF)	
315	R/W	IEEE Float	P3 Sensor Max Pressure	
317	R/W	16 bit	P3 Sensor MaxP, Day	
318	R/W	16 bit	P3 Sensor MaxP, Month	
319	R/W	16 bit	P3 Sensor MaxP, Year	



## DINTemp Register List:

ADDRESS	ACCESS	FORMAT	VALUE	DEFAULT
90-99	R	ASCII String	DINTemp Serial Number	
100	R	16 bit	Model Number	<b>2</b>
			2 = DINTemp	
101-102	R	IEEE Float	Software Version	
103	R/W	16 bit	Reset Control	
			bit 0 = System Reset	
			bit 1 = Reset to Defaults	
			bit 2 = Alarm Reset	
104-105	R/W	16 bit	Modbus Address	
			104 must be set to 0xa55a	<b>0xa55a</b>
			<b>registers 104-109 must be written as a block</b>	
			105 contains Modbus address	<b>30</b>
106	R/W	16 bit	Modbus Mode	<b>0</b>
			0 = RS485 RTU	
			1 = RS485 ASCII	
			2 = RS232 RTU	
			3 = RS232 ASCII	
			4 = USB RTU	
			5 = USB ASCII	
			6 = TCP	
107	R/W	16 bit	Modbus Baud Rate (115200 Default)	<b>8</b>
			0 = 1200	
			1 = 2400	
			2 = 4800	
			3 = 9600	
			4 = 19200	
			5 = 28800	
			6 = 38400	
			7 = 57600	
			8 = 115200	
108	R/W	16 bit	Modbus Serial Word Length (7 or 8)	<b>8</b>
109	R/W	16 bit	Modbus Serial Parity (Even, 1 Stop Bit default)	<b>2</b>
			0 = none, 2 Stop Bits	
			1 = odd, 1 Stop Bit	
			2 = even, 1 Stop Bit	
110	R/W	16 bit	TCP Address P1	<b>192</b>
111			TCP Address P2	<b>168</b>
112			TCP Address P3	<b>0</b>
113			TCP Address P4	<b>144</b>

114	R/W	16 bit	TCP Mask P1	<b>255</b>
115			TCP Mask P2	<b>255</b>
116			TCP Mask P3	<b>255</b>
117			TCP Mask P4	<b>0</b>
118	R/W	16 bit	TCP Gateway P1	<b>192</b>
119			TCP Gateway P2	<b>168</b>
120			TCP Gateway P3	<b>0</b>
121			TCP Gateway P4	<b>1</b>
130	R/W	16 bit	RTCC Control	
			bit 0 = Set Clock Values	
			<b>Registers 130-137 must be written as a block</b>	
131	R/W	16 bit	Day of Week (1-7)	
132	R/W	16 bit	Month	
133	R/W	16 bit	Day	
134	R/W	16 bit	Year	
135	R/W	16 bit	Hour (24)	
136	R/W	16 bit	Minute	
137	R/W	16 bit	Second	
140	R/W	16 bit	Temperature Units	<b>0</b>
			0 = C	
			1 = F	
141-142	R/W	IEEE Float	Cal Temperature (Default 25C) (Only change for use with a Custom Calibration)	<b>25.0</b>
150	R	16 bit	T1 Status	
			bit 0 = Disconnected	
			bit 1 = Uncalibrated	
			bit 2 = Low Alarm	
			bit 3 = High Alarm	
			bit 6 = Cal in Progress	
151-152	R	IEEE Float	T1 Temperature Value	
153	R	16 bit	T2 Status	
			bit 0 = Disconnected	
			bit 1 = Uncalibrated	
			bit 2 = Low Alarm	
			bit 3 = High Alarm	
			bit 6 = Cal in Progress	
154-155	R	IEEE Float	T2 Temperature Value	
156	R	16 bit	T3 Status	
			bit 0 = Disconnected	
			bit 1 = Uncalibrated	
			bit 2 = Low Alarm	
			bit 3 = High Alarm	

			bit 6 = Cal in Progress	
157-158	R	IEEE Float	T3 Temperature Value	
160-161	R/W	IEEE Float	T1 Temperature Alarm Limit - Low	<b>0.0</b>
162-163	R/W	IEEE Float	T1 Temperature Alarm Limit - High	<b>0.0</b>
164-165	R/W	IEEE Float	T2 Temperature Alarm Limit - Low	<b>0.0</b>
166-167	R/W	IEEE Float	T2 Temperature Alarm Limit - High	<b>0.0</b>
168-169	R/W	IEEE Float	T3 Temperature Alarm Limit - Low	<b>0.0</b>
170-171	R/W	IEEE Float	T3 Temperature Alarm Limit - High	<b>0.0</b>
201	R/W	16 bit	T1 Sensor ID Type	
			0 = Luer	
			1 = 3/8" Barb	
			2 = 1/2" Barb	
			3 = 3/4" TC	
			4 = 1" TC	
			100 = Cal Fixture	
202	R/W	16 bit	T1 Sensor ID Material	
			0 = Polypropylene	
			1 = Polysulfone	
203	R/W	16 bit	T1 Sensor ID Month	
204	R/W	16 bit	T1 Sensor ID Year	
205	R/W	16 bit	T1 Sensor ID Lot	
206	R/W	16 bit	T1 Sensor ID Unit Number	
210	R/W	IEEE Float	T1 Sensor Cal Factor (CF)	
220	R/W	16 bit	T1 Sensor Custom Cal Status	
			bit 0 = Invalid	
			bit 1 = Start Zero	
			bit 6 = Cal in Progress	
			bit 7 = Write Cal Data	
223	R/W	IEEE Float	T1 Sensor Custom Cal Factor (CCF)	
241	R/W	16 bit	T2 Sensor ID Type	
			0 = Luer	
			1 = 3/8" Barb	
			2 = 1/2" Barb	
			3 = 3/4" TC	
			4 = 1" TC	
			100 = Cal Fixture	
242	R/W	16 bit	T2 Sensor ID Material	
			0 = Polypropylene	
			1 = Polysulfone	
243	R/W	16 bit	T2 Sensor ID Month	
244	R/W	16 bit	T2 Sensor ID Year	
245	R/W	16 bit	T2 Sensor ID Lot	

246	R/W	16 bit	T2 Sensor ID Unit Number	
250	R/W	IEEE Float	T2 Sensor Cal Factor (CF)	
260	R/W	16 bit	T2 Sensor Custom Cal Status	
			bit 0 = Invalid	
			bit 1 = Start Zero	
			bit 6 = Cal in Progress	
			bit 7 = Write Cal Data	
263	R/W	IEEE Float	T2 Sensor Custom Cal Factor(CCF)	
281	R/W	16 bit	T3 Sensor ID Type	
			0 = Luer	
			1 = 3/8" Barb	
			2 = 1/2" Barb	
			3 = 3/4" TC	
			4 = 1" TC	
			100 = Cal Fixture	
282	R/W	16 bit	T3 Sensor ID Material	
			0 = Polypropylene	
			1 = Polysulfone	
283	R/W	16 bit	T3 Sensor ID Month	
284	R/W	16 bit	T3 Sensor ID Year	
285	R/W	16 bit	T3 Sensor ID Lot	
286	R/W	16 bit	T3 Sensor ID Number	
290	R/W	IEEE Float	T3 Sensor Cal Factor (CF)	
300	R/W	16 bit	T3 Sensor Custom Cal Status	
			bit 0 = Invalid	
			bit 1 = Start Zero	
			bit 6 = Cal in Progress	
			bit 7 = Write Cal Data	
303	R/W	IEEE Float	T3 Sensor Custom Cal Factor (CCF)	

## SciCon Disposable Conductivity / Temperature Sensors:

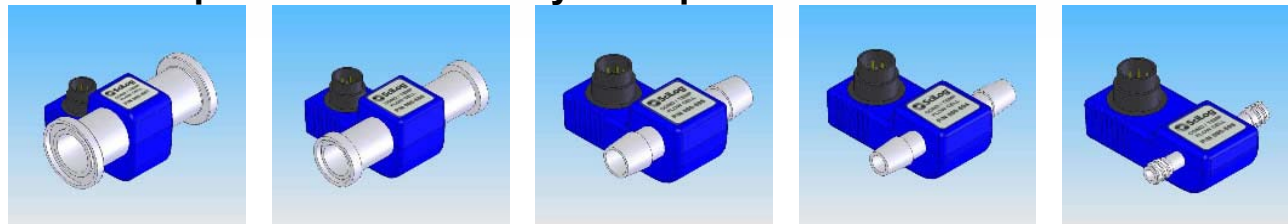

CONNECTOR TYPE	Max FLOW RATE	Max PRESSURE	NOMINAL CELL VOLUME
Luer	1 liter/min	60 psi	80 $\mu$ l
3/8" Barb	8 liters/min	60 psi	0.5 ml
1/2" Barb	17 liters/min	60 psi	0.8 ml
3/4" TC	31 liters/min	60 psi	1.2 ml
1" Ladish TC	60 liters/min	60 psi	2.3 ml
<b>Specifications for all SciCon™ Conductivity Flow Thru Sensors</b>			
<b>Material, Fluid Contact:</b>	Polysulfone (PS) w/Gold Electrodes; Medical Grade meets USP Class VI and FDA 21 CFR 177.1520. All Wetted Materials are made of Animal-Free Compounds. Most Sanitizing Agents such as NaOH, Hypochlorite. Sensors can be autoclaved..		
<b>Sensor Type:</b>	4-electrode conductivity cell Factory calibrated, Ready to use		
<b>Conductivity Range:</b>	1 $\mu$ S/cm to 200 mS/cm		
<b>Accuracy:</b>	High Range: $\pm$ 0.25 mS in the 0.1 - 200 mS range; Low Range: $\pm$ 3 $\mu$ S in the 0 - 100 $\mu$ S range.		
<b>Temperature Range:</b>	0 - 50 Celsius		
<b>Temperature Probe:</b>	Thermistor, Factory Calibrated		
<b>Temp. Accuracy:</b>	+/- 0.5 Celsius		
<b>Sensor Microchip:</b>	EPROM, stores Device ID, Cell Constant, Temp Offset & Factory Cal Data		

## SciPres Disposable Pressure Sensors:



CONNECTOR TYPE	Max FLOW RATE *	Max PRESSURE	NOMINAL CELL VOLUME
Luer	1 liter/min	60 psi	80 $\mu$ l
3/8" Barb	8 liters/min	60 psi	0.5 ml
1/2" Barb	17 liters/min	60 psi	0.8 ml
3/4" TC	31 liters/min	60 psi	1.2 ml
1" Ladish TC	60 liters/min	60 psi	2.3 ml
*At a 1.0 psi drop across the sensor			

### Specifications for all SciPres Flow Thru Pressure Sensors

<b>Material, Fluid Contact:</b>	Medical Grade Polysulfone meets USP Class VI and FDA 21CFR177.1520. All Wetted Materials are made of Animal-Free Compounds. Compatible with Most Sanitizing Agents such as NaOH, Hypochlorite. Sensors can be autoclaved.
<b>Sensor Type:</b>	Medical grade silicone piezoresistive sensing element with on-chip temperature compensation
<b>Sensor Isolation:</b>	Insoluble silicone dielectric gel isolates sensing element from process solution.
<b>Pressure Sensor Range:</b>	0-60 psi for all sizes.
<b>Pressure Sensor Accuracy:</b>	+/- 0.30 psi 0-60 psi.
<b>Pressure Sensor Resolution:</b>	0.01 psi.
<b>Temperature Range:</b>	0 - 60 Celsius
<b>Pressure Sensor Microchip:</b>	EPROM, stores Device ID, Cell Constant, Temp Offset & Factory Cal Data
<b>Pressure Sensor Cleaning:</b>	Sensors may be flushed with Alcohol, 0.1M or 0.5M NaOH, dilute Bleach, or Formaldehyde for inline sanitization several times. The Sensors may also be autoclaved.
<b>Sensor Connector and Cables:</b> Lockable & Waterproof	



**The maximum recommended pressure for the sensors is 60 psi. If this is exceeded, problems with leakage and functionality can occur.**

## SciTemp Disposable Temperature Sensors:



CONNECTOR TYPE	Max FLOW RATE *	Max Pressure	
Luer	1 liter/min	60 psi	
3/8" Barb	8 liters/min	60 psi	
1/2" Barb	17 liters/min	60 psi	
3/4" TC	31 liters/min	60 psi	
1" Ladish TC	60 liters/min	60 psi	
*At a 1.0 psi drop across the sensor			
<b>Specifications for all SciTemp™ Temperature Sensor Flow Thru Temperature Sensors</b>			
<b>Material, Fluid Contact:</b>	Natural PP, meets USP Class VI and FDA 21 CFR 177.1520 Medical Grade Polysulfone meets USP Class VI and FDA 21CFR177.1520. All Wetted Materials are made of Animal-Free Compounds. Compatible with Most Sanitizing Agents such as NaOH, Hypochlorite. Sensors can be autoclaved.		
<b>Sensor Type:</b>	Thermistor, Epoxy Coated, 2252 ohm.		
<b>Temperature Sensor Range:</b>	-40 to +150 ° C for all sizes.		
<b>Temperature Sensor Accuracy:</b>	0.01° C In the 4.0 to 70.0° C Range.		
<b>Temperature Sensor Resolution:</b>	0.01° C.		
<b>Temperature Sensor Microchip:</b>	EPROM, stores Device ID & Factory Cal Data		
<b>Temperature Sensor Cleaning:</b>	Sensors may be flushed with Alcohol, 0.1M or 0.5M NaOH, dilute Bleach, or Formaldehyde for inline sanitization several times. The Sensors may also be autoclaved.		
<b>Sensor Connector and Cables: Lockable &amp; Waterproof</b>			

## SciCon Sensor Sanitization Test Protocol

### Parker/Scilog DN 3023: SciCon Sanitization, 1.0 Molar NaOH @ 22 °C and 50 °C, 2 Hours

Group 1: SciCon Sensor Conductivity Response after Exposure to 1.0 N NaOH Solution, Temperature (1.0 N NaOH) at 22 °C, 2 Hours												
Group 1	TRIAL 1				TRIAL 2				TRIAL 3			
Temperature 22 °C	NIST	SciCon	NIST	SciCon	NIST	SciCon	NIST	SciCon	NIST	SciCon	NIST	SciCon
Sensor ID	Cond.	Cond.	Temp	Temp	Cond.	Cond.	Temp	Temp.	Cond.	Cond.	Temp.	Temp.
C1-240173-0308	13.04	13.10	25.64	25.4	13.04	13.14	24.70	24.3	13.04	13.10	24.99	24.8
C1-240251-0308	13.04	13.06	25.64	25.5	13.04	13.11	24.70	24.4	13.04	13.08	24.99	24.8
C1-240302-0308	13.04	13.00	25.64	25.7	13.04	13.05	24.70	24.6	13.04	13.04	24.99	25.0
<b>Group Average.</b>	<b>13.04</b>	<b>13.05</b>	<b>25.64</b>	<b>25.5</b>	<b>13.04</b>	<b>13.10</b>	<b>24.7</b>	<b>24.4</b>	<b>13.04</b>	<b>13.07</b>	<b>24.99</b>	<b>24.9</b>
<b>Group SD*</b>		<b>0.05</b>		<b>0.2</b>		<b>0.05</b>		<b>0.2</b>		<b>0.03</b>		<b>0.1</b>
SD* = Standard Deviation												
Group 2: SciCon Sensor Conductivity Response after Exposure to 1.0 N NaOH Solution, Temperature (1.0 N NaOH) at 50° C, 2 Hours.												
Group 2	TRIAL 1				TRIAL 2				TRIAL 3			
Temperature 50 °C	NIST	SciCon	NIST	SciCon	NIST	SciCon	NIST	SciCon	NIST	SciCon	NIST	SciCon
Sensor ID	Cond.	Cond.	Temp	Temp	Cond.	Cond.	Temp	Temp.	Cond.	Cond.	Temp.	Temp.
C1-240010-0208	13.04	13.02	25.64	25.7	13.04	13.12	24.70	24.6	13.04	13.10	24.99	25.0
C1-240060-0208	13.04	13.20	25.64	25.5	13.04	13.26	24.70	24.4	13.04	13.21	24.99	24.9
C1-240100-0208	13.04	12.91	25.64	25.5	13.04	12.93	24.70	24.7	13.04	12.84	24.99	25.2
<b>Group Average:</b>	<b>13.04</b>	<b>13.04</b>	<b>25.64</b>	<b>25.6</b>	<b>13.04</b>	<b>13.10</b>	<b>24.7</b>	<b>24.6</b>	<b>13.04</b>	<b>13.05</b>	<b>24.99</b>	<b>25.0</b>
<b>Group SD</b>		<b>0.15</b>		<b>0.1</b>		<b>0.17</b>		<b>0.2</b>		<b>0.19</b>		<b>0.2</b>

**NOTE:** Parker sensors are designed for disposable, single-use applications. However, with proper care, the Parker sensors can be re-used repeatedly while maintaining good accurate and precision. If required, SciCon sensors can be re-calibrated.

**CAUTION:** Do Not Exceed Maximum Pressure of 60 psi

**Test Protocol:** Six pre-calibrated (13.04 mS) SciCon Luer conductivity sensors were exposed 3 times to 1.0 molar NaOH for two hours each at 22 °C (Group1) and at 50 °C (Group 2). After each 2-hour exposure, the sensors were flushed 3x with distilled water and inserted into a temperature controlled glove box. A solution was then circulated through the sensors utilizing a peristaltic recirculation pump. The sensors were conductivity-tested and temperature-tested at the indicated standard values. The conductivity standard of the solution was tested using a NIST-traceable (YSI Model 30) conductivity meter. The temperature standard was measured using a NIST traceable temperature thermometer. The sensor responses were tabulated. The original factory calibration was maintained during the trials; no additional sensor calibrations were carried out before or during the trials. For this test, SciCon sensors were randomly selected from Parker inventory.



## SciCon Sensor Autoclave Test Protocol

Parker/SciLog DN 3130: SciCon Conductivity Sensor, Post Autoclaving Sensor Response.

***For accurate performance, SciCon sensors should not be autoclaved more than two times.***

**Objective:** Test SciCon Sensor Response after Repeated (4) Autoclave Cycles. Sterilization Conditions: Sterilization Temperature; 257°F (125°C), Sterilization Time: 30 min. Pressure: 19psi, Drying Time: 30 min. Conductivity Test Solution: 12.99mS (KCl)

SciCon, Luer	Pre-Autoclave Response	Post Trial 1 Response	Post Trial 2 Response	Post Trial 3 Response	Post Trial 4 Response
Sensor ID	mS	mS	mS	mS	mS
C1-240061-0208	12.86	12.91	12.94	12.84	12.80
C1-240058-0208	12.96	12.93	12.96	12.67	12.77
C1-240406-0208	12.93	12.99	12.41	12.66	12.60
C1-240059-0208	13.08	13.06	13.09	12.93	13.20
C1-240062-0208	13.02	12.97	13.14	13.01	13.09
<i>Group Average</i>	<b>12.97</b>	<b>12.97</b>	<b>12.91</b>	<b>12.82</b>	<b>12.89</b>
<i>Group SD*</i>	<b>0.08</b>	<b>0.06</b>	<b>0.29</b>	<b>0.16</b>	<b>0.25</b>

\* SD = Standard Deviation

**NOTE:** Parker sensors have been designed for disposable, single-use applications. However, with proper care, the sensors can be re-used repeatedly while maintaining good accuracy and precision. If required, sensors can be re-calibrated.

**CAUTION: Do Not Exceed Maximum Pressure of 60 psi**

**Test Protocol:** Prior to autoclaving, factory-calibrated SciCon conductivity sensors (5) were removed from inventory and tested against a conductivity solution (12.99 mS) in a temperature equilibrated glove box. The "out-of-box" sensor response data is listed as "Pre-Autoclave" in the table above. The 8-pin sensor connectors were sealed with autoclavable tape (Cole-Parmer P/N: EG-08277-62) The sensors were placed into paper bag (6 1/2"x 4" x12 3/8") and placed in a Tuttnauer EZ9 Autoclave. The following conditions were maintained throughout the four autoclaving trials: 1. Sterilization Temperature: 257°F (125 °C); 2. Sterilization Time: 30 min; 3. Sterilization Pressure: 18 psi, 4. Drying Time 30 min. After each trial, the SciCon sensors were allowed to cool for one hour inside the temperature controlled (25.0 °C) glove box. 12.99 mS test solution was re-circulated through the five, in-line sensors assembly for 30 min before reading the conductivity values. The SciCon sensor response data (displayed by the SciPres Monitor) is listed in the table above as "Post-Trial 1", "Post-Trial 2", "Post-Trial 3" and "Post Trial 4." Post-autoclave sensor response tests were carried out with the original factory calibration. No sensor re-calibration were made before, during or after the three trials.

**Summary:** All SciCon sensors survived the four autoclave trials. However, sensor accuracy becomes increasingly compromised after multiple autoclave cycles. ***For accurate performance, SciCon sensors should not be autoclaved more than two times.***

## SciPres Sensor Sanitization Test Protocol

### Parker/SciLog DN 3021: SciPres Pressure Sensor Sanitization Protocol (1):

Sanitizing Agent (2)	Conc.	Temp. ° C	pH	Pressure psi (4)	Contact Time, Min	Sani-Cycles Limit (3)	%SD (6) 10 Cycles
NaOH	0.10 N	20-30	13	0 - 10	15-30	10	0.20%
NaOH	0.50 N	20-30	13.5	0 - 10	15-30	10	0.25%
NaOCl (5)	500 ppm	20-30	7 - 8	0 - 10	15-30	10	0.70%
Formaldehyde Solution	1 - 2%	20-30	5 - 8	0 - 10	30	10	0.10%
Isopropyl Alcolol	70%	20-30	N/A	0 - 10	15-30	10	0.10%

#### NOTE:

1. SciPres pressure sensors have been designed for disposable, single-use applications. However, with proper care, SciPres sensors can be re-used repeatedly while maintaining good accuracy and precision. If required, the SciPres sensor can be re-calibrated.
2. SciPres sensors can be repeatedly sanitized with any of the listed sanitizing solutions. Do not exceed the recommended number of sanitization cycles. Sensor accuracy and precision will be affected adversely by excessive cleaning/sanitization.
3. Recommended number of cleaning / sanitization cycles.
4. Do not exceed recommended sanitization pressure range.
5. 1:100 dilution of Clorox Bleach, 500 ppm of active chlorine.
6. Response variance (% standard deviation) of pre-calibrated (30 psi) sensors over 10 sanitization cycles

#### CAUTION: *Do Not Exceed Maximum Pressure of 60 psi*

**Test Protocol:** Pre-calibrated (30.00 psi) SciPres pressure sensors were exposed to sanitizing solution by pumping the solution through the sensor for 30 minutes, followed by a distilled-water flush. Sensor response recovery was tested after each sanitization cycle by applying 30.00 psi of air pressure while monitoring the sensor response. Ten, 30-minute sanitization cycles were implemented; 5 hours of total cumulative exposure.

## SciPres Sensor Autoclave Test Protocols

**Parker/SciLog DN 3127:** *SciPres Pressure Sensor, Post Autoclaving Sensor Response.*

**Objective:** Test SciPres Sensor Response after Repeated (3) Autoclaving Cycles. Autoclaving Conditions: Sterilization Temperature: 257°F (125°C); Sterilization Time: 30min., Pressure: 19 psi, Drying Time: 30min.

**For accurate performance, sensors should not be autoclaved more than two times.**

SciPres 0.50" Barb	Pre-Autoclave		Post Trial 1		Post Trial 2		Post Trial 3	
	psi	psi	psi	psi	psi	psi	psi	psi
Sensor ID	NIST 0.00	NIST 30.00	NIST 0.00	NIST 30.02	NIST 0.00	NIST 30.00	NIST 0.00	NIST 30.02
S3-220221-1007	0.00	29.99	0.01	30.06	0.02	30.04	0.04	30.04
S3-220227-1007	0.00	29.99	0.00	30.06	0.02	30.05	0.04	30.06
S3-220229-1007	0.00	29.99	0.02	30.10	0.03	30.06	0.04	30.07
S3-220230-1007	0.00	29.99	0.01	30.06	0.30	30.24	NR	NR
S3-220234-1007	0.00	29.99	0.00	30.05	0.10	30.22	0.05	30.06
S3-220240-1007	0.00	30.00	0.02	30.06	0.79	31.06	NR	NR
<i>Group Average</i>	<b>0.00</b>	<b>29.99</b>	<b>0.01</b>	<b>30.07</b>	<b>0.21</b>	<b>30.28</b>	<b>0.04</b>	<b>30.06</b>
<i>Group SD*</i>		<b>0.00</b>		<b>0.02</b>		<b>0.39</b>		<b>0.01</b>
* SD = Standard Deviation		NR = No and/or Erratic Response						

**Test Protocol:** Prior to autoclaving, factory-calibrated SciPres sensors (6) were removed from inventory and pressure-tested at 0.00 and 30.00 psi. The "out-of-box" sensor response data are listed as "Pre-Autoclave" in the table above. The SciPres sensor ambient air-vent as well as the 8-pin sensor connector were covered with autoclavable tape (Cole-Parmer P/N: EG-08277-62). The sensors were placed into a paper bag (6 1/2"x 4" x12 3/8"), sealed with tape and placed in a Tuttnauer EZ9 Autoclave. The following conditions were maintained throughout the three autoclaving trials: 1. Sterilization Temperature: 257°F (125 °C); 2. Sterilization Time: 30 min; 3. Sterilization Pressure: 19 psi, 4. Drying Time 30 min.

After each trial, the SciPres sensors were allowed to cool to room temperature for one hour, followed by pressure tests at 0.00 psi and at 30.00psi. The applied pressure (30 psi) was generated with a regulated nitrogen gas source while monitoring the applied pressure with a NIST-traceable pressure gauge. The SciPres sensor response data (displayed by the SciPres Monitor) are listed in the table above as "Post-Trial 1", "Post-Trial 2" and "Post-Trial 3".

Post-autoclave sensor response tests were carried out with the original factory calibration. No sensor re-calibrations were made before, during or after the three trials.

**Summary:** *The tested SciPres sensors survived the autoclave conditions. However, sensor accuracy becomes increasingly compromised after multiple autoclave cycles. **For accurate performance, sensors should not be autoclaved more than two times.***

**NOTE:** Parker sensors have been designed for disposable, single-use applications. However, with proper care, the sensors can be re-used while maintaining good accuracy and precision. If required, sensors can be re-calibrated. **CAUTION: Do Not Exceed Maximum Pressure of 60 psi**

## SciTemp™ Temperature Sensor Sanitization Test Protocols

### SciTemp Sanitization Protocol (1):

Sanitizing Agent (2)	Conc.	Temp. ° C	pH	Pressure psi (4)	Contact Time, Min	Sani-Cycles Limit (3)
NaOH	0.10 N	20-30	13	0 - 10	15-30	10
NaOH	0.50 N	20-30	13	0 - 10	15-30	10
NaOCl (5)	500 ppm	20-30	7 - 8	0 - 10	15-30	10
Formaldehyde Solution	1 - 2%	20-30	5 - 8	0 - 10	30	10
Isopropyl Alccol	70%	20-30		0 - 10	15-30	10

#### Notes:

- (1) SciTemp sensor sanitization should be performed after flow cell has been thoroughly cleaned and flushed with distilled water.
- (2) SciTemp sensors can be repeatedly sanitized with any of the listed sanitizing solutions. Do not exceed the recommended number of sanitization cycles. Sensor accuracy and precision will be affected by excessive cleaning / sanitization.
- (3) Recommended, Maximum Number of Cleaning / Sanitization cycles.
- (4) Do Not Exceed Recommended Sanitizing Pressure Range
- (5) 1:100 dilution of Clorox Bleach, 500 ppm of Active Chlorine

**Test Protocol:** Pre-calibrated SciTemp flow-through Temperature sensors were exposed to sanitizing solution by pumping the solution through the sensor for 30 minutes, followed by a distilled-water flush. Sensor response recovery was tested after each sanitization cycle.

## SciTemp Sensor Autoclave Test Protocols

**Parker/SciLog DN 3131:** SciTemp Temperature Sensor, Post Autoclaving Sensor Response

**Objective:** Test SciTemp Sensor Response after Repeated (3) Autoclaving Cycles. Autoclaving Conditions: Sterilization Temperature: 257°F (125°C); Sterilization Time: 30min., Pressure: 19 psi, Drying Time: 30min.

**For accurate performance, sensors should not be autoclaved more than two times.**

SciTemp, Luer Sensor ID	Pre-Autoclave			Post Trial 1			Post Trial 2			Post Trial 3		
	NIST T1	SciTemp T2	$\Delta T$	NIST T1	SciTemp T2	$\Delta T$	NIST T1	SciTemp T2	$\Delta T$	NIST T1	SciTemp T2	$\Delta T$
A1-210164-0108	25.07	25.00	0.07	25.01	25.03	-0.02	24.88	24.96	-0.08	25.05	24.96	0.09
A1-210165-0108	25.07	25.02	0.05	25.01	25.05	-0.04	24.88	24.96	-0.08	25.05	25.05	0.00
A1-210166-0108	25.07	25.04	0.03	25.01	25.06	-0.05	24.88	24.98	-0.10	25.05	NR	
A1-210167-0108	25.07	25.05	0.02	25.01	25.04	-0.03	24.88	24.91	-0.03	25.05	24.98	0.07
A1-210168-0108	25.07	25.06	0.01	25.01	25.05	-0.04	24.88	24.94	-0.06	25.05	25.07	-0.02
Group Average		<b>25.03</b>			<b>25.05</b>			<b>24.95</b>			<b>25.02</b>	
Group SD*		<b>0.02</b>			<b>0.01</b>			<b>0.03</b>			<b>0.05</b>	
* SD = Standard Deviation						NR = No and/or Erratic Response						

**Test Protocol:** Prior to autoclaving, factory-calibrated SciTemp sensors (5) were removed from inventory and temperature-tested at 25.00 °C in a temperature equilibrated glove box. The "out-of-box" sensor response data is listed as "Pre-Autoclave" in the table above. The SciTemp sensor air-vent as well as the 8-pin sensor connector were sealed with autoclavable tape (Cole-Parmer P/N: EG-08277-62). The sensors were placed into a paper bag (6 1/2"x 4" x12 3/8"), sealed with tape and placed in a Tuttnauer EZ9 Autoclave. The following conditions were maintained throughout the three autoclaving trials: 1. Sterilization Temperature: 257°F (125 °C); 2. Sterilization Time: 30 min; 3. Sterilization Pressure: 18 psi, 4. Drying Time 30 min.

After each trial, the SciTemp sensors were placed in a temperature equilibrated glove box for 45 minutes. Utilizing a peristaltic pump, a temperature equilibrated solution (0.100 molar KCl, 25 °C) was re-circulated through the in-line SciTemp sensor assembly. An in-line NIST-traceable thermistor was used as a temperature reference. Four of the five SciTemp sensors survived the three autoclaving trials while maintaining good sensor accuracy and precision during the initial autoclave cycles. All trial measurements were carried out with the original factory calibration. No sensor re-calibration were made before, during or after the three post-autoclave trials.

**Summary:** *Sensor accuracy becomes increasingly compromised after the multiple autoclave cycles. For accurate performance, sensors should not be autoclaved more than two times.*

**NOTE:** Parker sensors have been designed for disposable, single-use applications. However, with proper care, the sensors can be re-used while maintaining good accuracy and precision. If required, sensors can be re-calibrated. **CAUTION: Do Not Exceed Maximum Pressure of 60 psi.**

## Din Module Manual Revision History

Rev. #	Date	Author	Description
<b>A</b>	11/1/08	A.Dawson	Creation of preliminary manual
<b>B</b>	11/20/08	A.Dawson	First Release
<b>C1</b>		A.Dawson	Updated to reflect cable changes based on testing from ETL.
<b>C2</b>	11/19/09	A.Dawson	Addition of note in Modbus section and correction of register 109 settings to reflect pre-set stop bit values, even, odd =1, none =2
<b>C3</b>	3/26/10	A.Dawson	Corrected error in RS485 A/B pin designation, it was reversed. Removed Bit 4 Error from Sensor Status Registers, it is unused.
<b>IOMI</b>	02/07/18	A.Dawson	Converted to Parker format, minor technical corrections.

---

# Notes

A series of horizontal dashed lines for writing notes.

---

# Notes

A series of horizontal dashed lines for writing notes.



---

# Notes

A series of horizontal dashed lines for writing notes.

---

© 2015 Parker Hannifin Corporation. All rights reserved.

IOMI-AK1-004\_RevB



Parker Hannifin Corporation  
Bioscience Division – N.A.  
2340 Eastman Avenue  
Oxnard, California, USA 93030  
toll free: 877 784 2234  
phone: +1 805 604 3400  
fax: +1 805 604 3401  
email: [bioscience.na@parker.com](mailto:bioscience.na@parker.com)  
[www.parker.com/bioprocessing](http://www.parker.com/bioprocessing)

Parker Hannifin Manufacturing Ltd  
Bioscience Division - EMEA  
Durham Road  
Birtley, Co. Durham  
DH3 2SF, England  
phone +44 (0)191 4105121  
fax +44 (0)191 4105312  
email: [bioscience.emea@parker.com](mailto:bioscience.emea@parker.com)  
[www.parker.com/bioprocessing](http://www.parker.com/bioprocessing)