



SciCon™ Conductivity Monitor & Sensor Operators Manual

Conductivity Monitoring with Disposable Sensors



ENGINEERING YOUR SUCCESS.

(This page left blank intentionally.)

Rev J3, 01/18, Firmware Version 0.38

Parker has a continuous policy of product development and although the Company reserves the right to change specification, it attempts to keep customers informed of any alterations. This publication is for general information only and customers are requested to contact our Process Filtration Sales Department for detailed information and advice on a product's suitability for specific applications. All products are sold subject to the company's Standard conditions of sale.

Precautions

READ this manual BEFORE operating or servicing this equipment.











FOLLOW these instructions carefully.

SAVE this manual for future reference.

DO NOT allow untrained personnel to operate, clean, inspect, service or tamper with this equipment.

ALWAYS DISCONNECT this equipment from the power source before cleaning or performing maintenance.

CALL Parker Customer Service for parts, information and service.

	<p style="text-align: center;"> WARNING</p> <p>DISCONNECT ALL POWER TO THIS UNIT BEFORE INSTALLING, SERVICING, CLEANING OR REMOVING THE FUSE. FAILURE TO DO SO COULD RESULT IN BODILY HARM AND/OR PROPERTY DAMAGE.</p>
	<p style="text-align: center;"> CAUTION</p> <p>OBSERVE PRECAUTIONS FOR HANDLING ELECTROSTATIC SENSITIVE DEVICES.</p>
	<p style="text-align: center;"> WARNING</p> <p>ONLY PERMIT QUALIFIED PERSONNEL TO SERVICE THIS EQUIPMENT. EXERCISE CARE WHEN MAKING CHECKS, TEST AND ADJUSTMENTS THAT MUST BE MADE WITH POWER ON. FAILING TO OBSERVE THESE PRECAUTIONS CAN RESULT IN BODILY HARM.</p>
	<p style="text-align: center;"> WARNING</p> <p>FOR CONTINUED PROTECTION AGAINST SHOCK HAZARD, CONNECT TO PROPERLY GROUNDED OUTLET ONLY. DO NOT REMOVE THE GROUND PRONG.</p>
	<p style="text-align: center;"> CAUTION</p> <p>USE ONLY CLASS 2 LISTED AC/DC POWER SUPPLIES WITH THIS DEVICE. Parker dominick hunter # 070-017TOR, OR ITS EQUIVALENT IS RECOMMENDED.</p>

Précautions

LISEZ ce manuel AVANT de faire fonctionner ou d'entretenir cet équipement.

SUIVEZ attentivement ces instructions.

CONSERVEZ ce manuel pour future référence.

NE LAISSEZ PAS du personnel non qualifié utiliser, nettoyer, inspecter, entretenir, réparer ou manipuler cet équipement.

DÉBRANCHEZ TOUJOURS cet équipement de la source de courant avant de nettoyer ou d'exécuter l'entretien.

APPELEZ PARKER pour pièces détachées, renseignements et entretien.

	<p style="text-align: center;"> ATTENTION</p> <p>DÉBRANCHEZ TOUT COURANT DE CETTE UNITÉ AVANT DE FAIRE L'INSTALLATION, D'EFFECTUER L'ENTRETIEN, LE NETTOYAGE OU AVANT DE RETIRER LE FUSIBLE. NE PAS OBSERVER CES PRÉCAUTIONS RISQUERAIT DE CAUSER DES BLESSURES CORPORELLES OU/ET D'ENDOMMAGER L'ÉQUIPEMENT.</p>
	<p style="text-align: center;"> PRUDENCE</p> <p>SOYEZ PRUDENT LORSQUE VOUS MANIPULEZ DES APPAREILS SENSIBLES À L'ÉLECTROSTATIQUE.</p>
	<p style="text-align: center;"> ATTENTION</p> <p>AUTORISEZ SEULEMENT LE PERSONNEL QUALIFIÉ À ENTREtenir CET ÉQUIPEMENT. SOYEZ PRUDENT LORSQUE DES VÉRIFICATIONS, TESTS ET AJUSTEMENTS DOIVENT ÊTRE EFFECTUÉS SOUS TENSIONS. NE PAS OBSERVER CES PRÉCAUTIONS RISQUERAIT DE CAUSER DES BLESSURES CORPORELLES.</p>
	<p style="text-align: center;"> ATTENTION</p> <p>POUR ASSURER UNE PROTECTION CONTINUE CONTRE UNE DÉCHARGE ÉLECTRIQUE, BRANCHEZ UNIQUEMENT SUR UNE PRISE CORRECTEMENT RELIÉE À LA TERRE. NE RETIREZ PAS LA FICHE DE TERRE.</p>
	<p style="text-align: center;"> PRUDENCE</p> <p>Utilisez la classe 2 énumérés AC / DC avec cet appareil. Parker Parker # 070-017TOR, Ou son équivalent est recommandé.</p>

Table of Contents:

Precautions:.....	3
Calibration:.....	5
Installation & Start-Up.....	6
Maintenance & Cleaning:.....	6
Introduction:.....	6
SciCon System Specifications:	8
Part A: SciCon™ Hardware.....	10
1. Overview:.....	10
2. Front Panel: Data Entry & Display	11
3. Back Panel: Interface Options	12
4. Disposable Conductivity / Temperature Sensors:	14
Part B: SciCon™ Software.....	15
5. Software Overview:.....	15
6. Main Menu	16
7. Custom Calibration Menu:	20
8. SciCon Printout Format.....	21
9. Data Collection	22
10. SciDoc Data Collection Software:.....	23
11. PC HyperTerminal Settings:	27
Appendix A: Sensor Performance Data	28

Calibration:

The SciCon Monitor is a calibrated device, and is calibrated with test equipment that is traceable to NIST.

A Calibration Certificate is included with each unit, and has a one year expiration date.

It is highly recommended that the monitor be calibrated on an annual basis or more often if your Metrology Department deems it necessary.

Parker provides this Calibration Service, complete with a new certificate, showing the “as found” and “as left” data.

Contact your Parter Territory Manager or Parker Technical Support to make arrangements at 805-604-3400 or 608-824-0500.

Standards:

The SciCon™ Conductivity Monitor and Sensors conform to the the following standards:

- EN 61326-1:2006, Class B
- EN 6100-3-2:2006
- EN 6100-3-3:1995 +A1:2001 +A2:2006
- EN 61010-1:2010 Ed.3+ C1;C2
- UL 61010-1:2012 Ed.3+ R: 29Apr2016
- CAN/CSA-C22.2 No 61010-1-12:2012 Ed.3+U1;U2



Installation & Start-Up:

Installation of the SciCon must be carried out only by trained personnel in accordance with the relevant regulations and this operations manual.

Make sure that the technical specifications and input ratings of the SciCon are observed. See “SciCon Specifications”

The protection provided by this equipment may be impaired, if the SciCon is used in a manner or for purposes not specified by the manufacturer, Parker Bioscience.

Maintenance & Cleaning:

The SciCon™ Conductivity Monitor is maintenance free. The disposable sensors come pre-calibrated from the factory and require no maintenance.

To remove dust, dirt and stains, the outer surfaces of the SciCon™ Conductivity Monitor may be wiped using a soft, non-fluffing cloth moistened with water. If required, you may also use a mild detergent or 2-propanol.

The disposable sensors may be sanitized with 0.1 Molar NaOH, or 2-propanol. They may be autoclaved, and newer units with the grey rings around the cable connector may be gamma irradiated.

Introduction:

You will find the SciCon™ system easy to use. The state-of-the-art hardware and software design of the SciCon allows you to measure and document the conductivity of many filtration / separation processes. With proper maintenance, the SciCon monitor will provide many years of excellent service and performance.

 **Please read the following instructions carefully!**

Inspections: Unpack the SciCon and accessories carefully from the carton. Cross-check the contents against your purchase order to verify that all parts are included and undamaged.

Please do the inspection now, even if the SciCon is not used immediately. Many carriers must receive damage claims within seven days of delivery. Please retain all packing material so unit may be shipped safely, if necessary.

Parker Customer Service:

If you need assistance, please call: **1-800-955-1993** or **1-608-824-0500**

Parker Customer Service personnel will be able to serve you more efficiently if you have the following information:

- Serial number (back panel) and model name of the equipment.
- Installation procedure you used.
- Concise list of symptoms.
- List of operating procedures and conditions you were using when problem arose.

Warranty Repair: Units covered under warranty will be repaired and returned to you at no charge. If you have any questions about applicability, please contact Parker Customer Service.

Non-warranty Repair: For out-of-warranty repair, contact the Parker Customer Service Department. A representative will discuss service options with you and can assist in making arrangements to return the equipment, if necessary.

Repair Procedure: Before returning any equipment for repair or service, contact Parker to obtain a TSP Number.

Carefully pack the unit to prevent damage in transit. Check with SciLog regarding the proper method of shipment. No responsibility is assumed by SciLog for damage caused by improperly packaged instruments. Indicate the RGA Number on the carton and on the packing slip. Always insure for the replacement value of the unit.

Include a description of the symptoms, your name, return address, phone number, RGA number and purchase order to cover repair costs, return and shipping charges, if your institution requires it. Ship to:

SciLog Inc.
8446 Excelsior Dr.
Madison, WI 53517

SciCon System Specifications:

Monitor:

Mechanical:

- **Dimensions:** Width: 6.0 in (15.2 cm); Height: 2.75 in (7.0 cm); Depth: 5.5 in (14.0 cm)
- **Weight:** 1.5 lbs (0.69kg)
- **Enclosure:** Aluminum / Molded plastic.

Electrical:

- **Power:** 110-120 or 220-240 VAC, 60/50Hz AC Adaptor; 12 VDC, 500 ma Output, Center positive. Use only Class 2 listed AC/DC power supplies.
- **Battery:** BR2032, used for internal clock only, not user serviceable.
- **Sensor:** Choice of five sensor sizes: Luer, 3/8" Hose barb, 1/2" Hose barb, 3/4" TriClover (TC) sanitary, and 1" TC ("Ladish") Sanitary.
- **I/O Ports:**
 - **"C/T Sensor"**, Female 9 pin twist-lock connector for Sensor cable.
 - **"Output"**, Female DB25, four TTL outputs for alarms, two 4-20 ma Analog Signals, (18 bit resolution) for Conductivity and Temperature.
 - **"Printer/PC"**, Female DB9, RS-232 output for serial printer or PC.
 - **"Serial I/O"**, Female DB9, Reserved for future use.
 - **"RS-485"**, 3 wire terminal block. RS-485 output, Reserved for future use.
 - **"12VDC 500ma"**, DC Input for AC adaptor.
- **Display:** Two line LCD, 20 characters each, back-lit.
- **Data Entry:** Membrane keyboard with auditory feedback.

Software:

Two operational modes:

- **Conductivity Mode:** Captures stored calibration from sensors, digital display of conductivity and temperature, analog display of conductivity, with four user-definable alarms.
- **Custom Calibration Mode:** Used to perform custom calibrations, selecting User-defined Temperature Offset and Calibration Concentration (solution).

Sensors:

Power: 5 VDC provided by SciCon monitor.

Fluid Connections: Luer, 3/8" Hose barb, 1/2" Hose barb, 3/4" TC, and 1" TC.

Wetted Materials: Polysulfone, Gold. meets USP Class VI and FDA 21 CFR 177.1520

Sensor Type: 4-electrode conductivity cell,
Factory calibrated, Ready to use.

Conductivity Range: 1 μ S/cm to 200 mS/cm

Precision Level: 2% across the entire range.

Temperature Range: 4 - 50° Celsius

Temperature Probe: Thermistor, Factory Calibrated.

Temperature Accuracy: +/- 0.5 Celsius

Sensor Microchip: EPROM, stores Device ID, Cell Constant, Factory Cal Data

Documentation Software for PC

SciCon SciDoc Software Package, P/N 080-099SCICON

Excel spreadsheet with custom macros for data compilation. Includes Winwedge interface software. Sent to you ready to use.

Complete process analysis with graphing of data

Real-time verification and documentation of process parameters

Includes graph of: Conductivity & Temperature vs. Time

Spreadsheet example:

SciCon v0.11: vS : TEMP REF = 25.0; TEMP COEF = 1.00; -ALARMS: HC= 0.0; LC= 0.0; HI= 0.00;C; LI= 0.00;C; Sensor ID=C1-001075-0200; CF= 1.00; TO=0.1; CCF= 1.00; CTO= 0.0				Operator	
				Date	
				Time	
				Product Batch Number	
				Product Description	
				Conditions	
				Membrane Manufacturer	
				Membrane Type	
				Membrane Lot Number	
				Membrane Serial Number	
Com Port Setup	Operator Info	Clear Data	Membrane Pore Size		
Membrane Surface Area, sq M	0.005				
Run Time	Conductivity	Temp	Alarm		
00:00:00	363.0	22.9			
00:00:00	363.0	22.9			
00:00:05	359.0	22.9			
00:00:10	774.0	22.8			
00:00:15	37227.0	22.8			
00:00:20	20462.0	22.8			
00:00:25	21704.0	22.8			
00:00:30	27958.0	22.8			
00:00:35	24279.0	22.8			
00:00:40	22932.0	22.8			
00:00:45	25105.0	22.8			
00:00:50	24617.0	22.8			
00:00:55	23690.0	22.8			
00:01:00	24159.0	22.8			
00:01:05	24294.0	22.8			
00:01:10	24011.0	22.8			

Graph example:

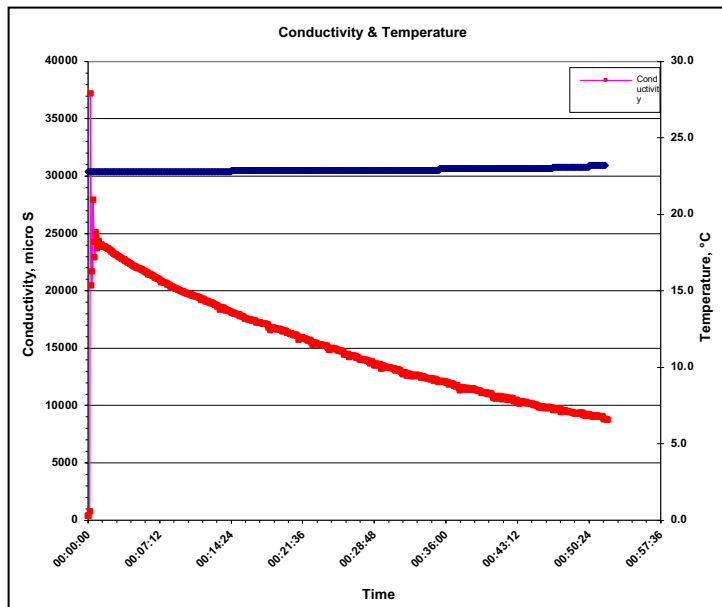

Part A: SciCon™ Hardware

Overview:

The SciCon™ consists of two major components, the SciCon Conductivity Monitor, with its power supply, and the Disposable SciCon Sensor, with its cable.

The Monitor is a small desktop package with a backlit display and seven buttons for easy interface and menu selections. It displays conductivity and temperature in real time in both digital and analog format. The monitor's output is also available in digital and analog formats, RS-232 and 4-20 mA. It comes with a small 110 VAC wall adapter as a power supply. (220/240 VAC adapters are available)

The Disposable SciCon Sensors utilize four gold plated electrodes in a polysulfone sensor body available in five sizes: Luer, 3/8" or 1/2" hose barb, 3/4" and 1" "Ladish" Sanitary TC connections.

For accurate measurements it is important that the sensors, solution and environment are allowed to equilibrate. If not done, the measurements will drift as the equilibration occurs during the run.

All are pre-calibrated at the factory, and retain the calibration data on a small chip embedded in the sensor body. The following information is retained and is accessed upon connection to the sensor:

- ID number (Contains Size, Lot number, Mfr Code, and Calibration date)
- Calibration Factor
- Temperature Offset

Front Panel: Data Entry & Display

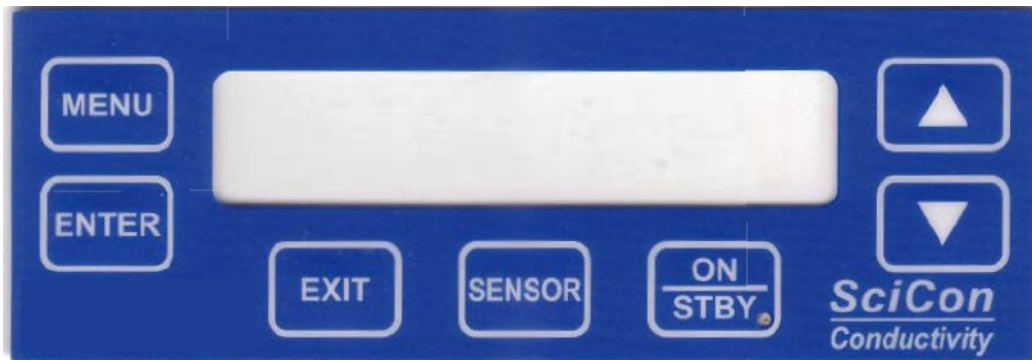

The front panel consists of a user interface, which includes an alphanumeric display and a membrane keypad to select operational modes and alarm settings. The display is a two line, 20 character, liquid crystal display (LCD). The display is backlit to allow easy viewing over a wide range of lighting conditions.

The keypad consists of seven keys whose function does not change. These keys are used for basic control and programming of the SciCon. The basic key definitions are:

- | | |
|----------------|---|
| MENU | Allows entry into the parameter settings menu. |
| ENTER | Accepts the selected parameter setting. |
| EXIT | Exits the menu, returning to the main operational screen. |
| SENSOR | Recaptures the factory calibration settings stored on the sensor, and allows entry into the custom calibration menu. This allows the user to calibrate with other known standard solutions. |
| ON/STBY | Turns the monitor on and off. |
| ▲ ▼ | Up and Down arrows used to change parameters within the menus. |

One LED is also on the front panel, on the ON/STBY key. This indicates the monitor is connected to power.

Back Panel: Interface Options

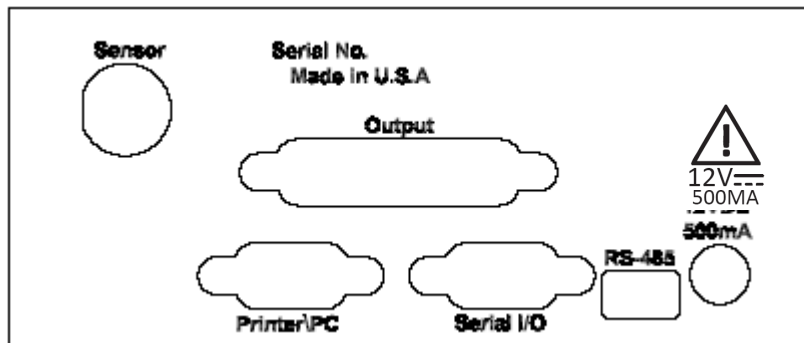

The SciCon back panel provides interfacing ports for:

Disposable SciCon Sensors: Female 9 pin twist-lock, labeled “Sensor”.

Analog and TTL Output: Female DB25, labeled “Output”.

RS-232: Female DB9, labeled “Printer/PC”.

Serial I/O: Female DB9, Reserved for future use.

RS-485: 3 wire terminal block, labeled “RS-485”, Reserved for future use.

Input power: Round connector for AC Adapter, labeled “12 VDC/500 mA”.

Sensor Port: The disposable conductivity sensors are connected here using the included cables.

Output Port: Provides two 4-20 mA analog outputs, (18 bit resolution) for Conductivity and Temperature, and TTL outputs for the 4 alarms, Hi/Low Conductivity, Hi/Low Temperature. TTL outputs provide a 5 VDC control signal, carry minimal current. (See Pin out on next page.)

Printer/PC Port: The printer is connected to the SciCon via this port.

A printer cable (P/N 080-096) is required to make the connection between the printer and the SciCon, or a Parker RS-232 cable (P/N 080-073) to connect the SciCon to a PC for data archival.

Serial I/O Port: Reserved for future use.

RS-485 Port: Reserved for future use.

Power Input Jack: Connection for the AC adapter.

Pin Out of the DB25 female “Output” connector:

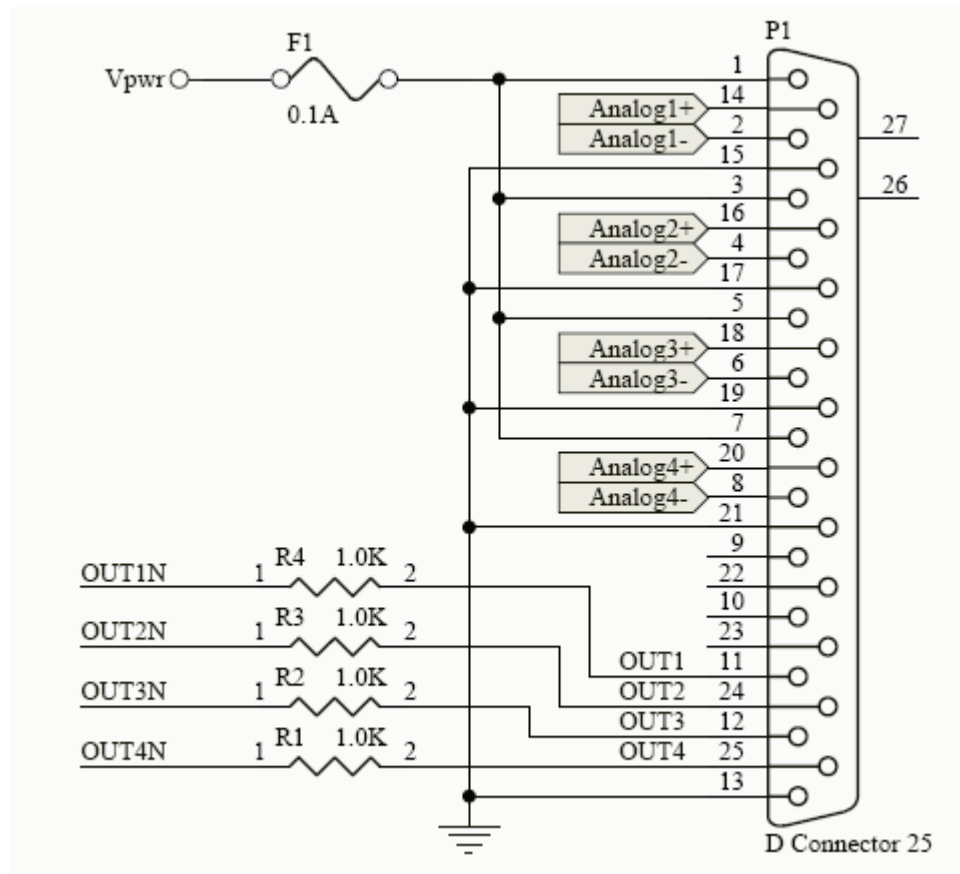

For 4-20 ma output of Conductivity (Analog 1), use pins 2 (4-20 -) and 14 (4-20 +). If excitation is needed in the loop, connect pin 1 (Vpwr) to pin 14 (4-20 +), and connect the output (signal) cable to pin 2 (4-20 -) and pin 15 (Gnd).

For 4-20 ma output of Temperature (Analog 2), use pins 4 (4-20 -) and 16 (4-20 +). If excitation is needed in the loop, connect pin 3 (Vpwr) to pin 16 (4-20 +), and connect the output (signal) cable to pin 4 (4-20 -) and pin 17 (Gnd).

Analog outputs 3 and 4 are not utilized in the SciCon.

TTL Outputs:

- | | |
|------------------------------|-----------------------------|
| Hi Conductivity Alarm: TTL 1 | Pins 11 (Out0) and 13 (Gnd) |
| Lo Conductivity Alarm: TTL 2 | Pins 24 (Out1) and 13 (Gnd) |
| Hi Temperature Alarm: TTL 3 | Pins 12 (Out2) and 13 (Gnd) |
| Lo Temperature Alarm: TTL 4 | Pins 25 (Out3) and 13 (Gnd) |

TTL outputs are either 0 or 5 VDC, and carry minimal current. They are for TTL inputs on a PLC, or control of a 5 VDC solid state electronic relay.

Disposable Conductivity / Temperature Sensors:



Connector Type	Max Flow Rate	Max Pressure	Nominal Cell Volume
Luer	2 liters/min	60 psi	80 μ l
3/8" Barb	8 liters/min	60 psi	0.5 ml
1/2" Barb	17 liters/min	60 psi	0.8 ml
3/4" TC	31 liters/min	60 psi	1.2 ml
1" Ladish TC	> 50 liters/min	60 psi	2.3 ml

Specifications for all SciCon Flow Thru Conductivity/Temperature Sensors	
Material, Fluid Contact:	Polysulfone, Gold The Polysulfone meets USP Class VI and FDA 21 CFR 177.1520
Sensor Type:	4-electrode conductivity cell Factory calibrated, Ready to use
Conductivity Range:	1 μ S/cm to 200 mS/cm, Resolution: 0.1 μ S
Accuracy:	High Range: +/- 0.25 mS in 10 – 200 mS Range Low Range: +/- 3.0 μ S in 0-100 μ S Range
Temperature Range:	4 - 50° C
Temperature Probe:	Thermistor, Factory Calibrated
Temp. Accuracy:	+/- 0.5 Celsius
Sensor Microchip:	EPROM, stores Device ID, Cell Constant, Temp Offset & Factory Cal Data Sensors with part numbers ending in "PSX" contain a gamma-stable EPROM

Part B: SciCon™ Software

Software Overview:

The SciCon Conductivity Monitor, upon connection to the Sensor, reads the stored Sensor ID and calibration data, displaying it as it is seen. The Monitor then displays the measured conductivity and temperature.

The data is displayed digitally as well as an analog display of % full scale.

The Menu allows the setting of concentration units (ppm of NaCl, KCl, and 442 are also available), the high and low analog range settings as well as the temperature reference and coefficient. The user may also adjust the baud rate and print time, and configure user-defined Hi/Low conductivity and temperature alarms.

The system is equipped with a user assigned Supervisor Password. When it is zero, it is disabled. Any other number up to 9999 can be used, and is required to access any menus.

The SciCon monitor will also allow custom calibration of the sensors using an alternative conductivity standard thru the use of the "Sensor" button on the front panel.

The display is updated continuously, and data is output via the RS-232 point at 5 second intervals by default. This frequency may be adjusted by the user.

Main Menu

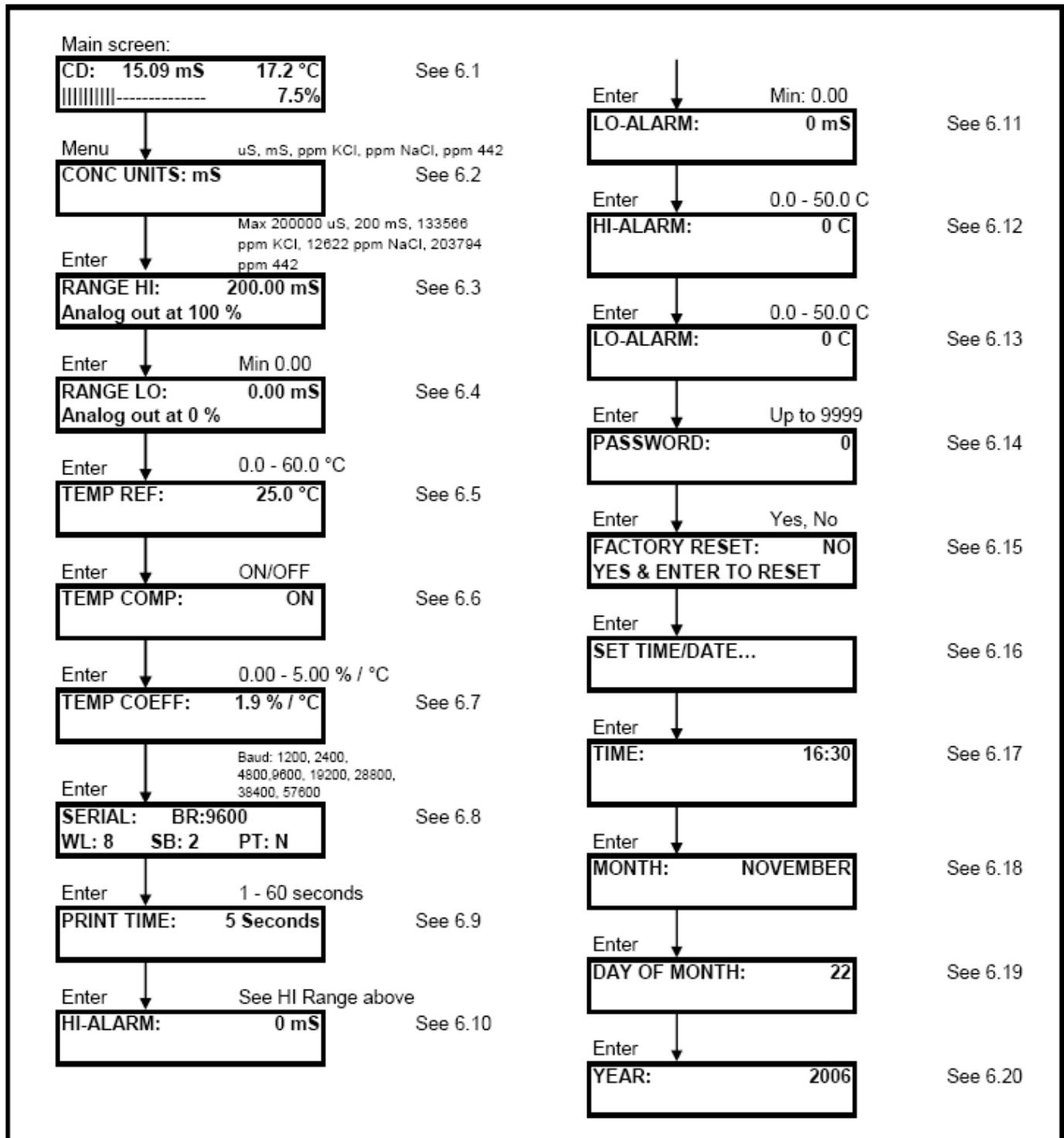

Main Menu:

SUMMARY: This menu allows the setting of various parameters as they relate to the process being monitored. Use “Menu” to scroll through the menu, the up/down arrow keys to scroll through choices, and “Enter” to select the choice.

NOTE: The analog output of the Temperature is over a range of 0-100°C, and is not adjustable.

- 6.1 **MAIN SCREEN:** Displays Conductivity (**CD:**), Temperature in **°C**. in line 1, and an analog bar graph of % of full scale (conductivity) along with the actual % value.
- 6.2 **CONCENTRATION UNITS:** Use the up / down arrows to select between μS (micro siemens), mS (milli siemens), ppm KCl (parts / million potassium chloride), ppm NaCl (parts / million sodium chloride), ppm 442 (parts / million 442 solution). Default = **μS**
- 6.3 **Range Hi:** Use to set the upper range limit of the Analog output signal (100% full scale). Allowable maximums are 200000 μS , 200 mS, 133566 ppm KCl, 12622 NaCl, 203794 ppm 442. Default = **200000 μS**
- 6.4 **RANGE LO:** Use to set lower range limit of the Analog output signal (0.0% of full scale). Default minimum is **0.0** regardless of scale.
- 6.5 **TEMP REF:** Reference Temperature. It can be changed if needed; all sensors are pre-calibrated using a reference temperature of 25.0 °C. Default = **25.0**
- 6.6 **Temp Comp:** Temperature Compensation. May be turned off if desired. Default = **On**.
- 6.7 **TEMP COEFF:** Temperature Coefficient. % to which the measurement is affected per °C of change. Default = **1.90% / °C**.
- 6.8 **Serial:** Displays the RS-232 serial output parameters. Only baud rate can be changed. Available rates are 1200, 2400, 4800, 9600, 19200, 28800, 38400 and 57600. Default = **9600**
- 6.9 **PRINT TIME:** Sets the data output interval, 1 to 60 sec. Default = **5 sec**.
- 6.10 **HI – ALARM:** Used to set High Conductivity Alarm, value should be within High and Low Range set above. Default = **0 μS**
- 6.11 **LO – ALARM:** Used to set Low Conductivity Alarm, value should be within High and Low Range set above. Default = **0 μS**
- 6.12 **HI – ALARM:** Set High Temperature Alarm, Max 50 °C. Default = **0.0 °C**.
- 6.13 **LO – ALARM:** Set Low Temperature Alarm, Max 50 °C. Default = **0.0 °C**.
- 6.14 **PASSWORD:** A numerical Password may be entered, with 0 being the default value, and equivalent to No Password. Once entered, the Password is required to enter any menu on the SciCon Monitor. Call Parker Technical Support if the password must be reset.
- 6.15 **FACTORY RESET:** Used to restore the SciCon Conductivity Monitor to the factory default values. Change No to Yes using the arrow keys and press “Enter” to reset, change No to Yes on the “Are You Sure?” screen and press “Enter” again to finish the process.
- 6.16 **SET TIME/DATE...** Press Enter to modify the Time Date Stamp used by the SciCon internal clock. Press Menu to bypass and return to the top of the menu, or Exit to leave the menu.

-
- 6.17 TIME:** Use the up / down arrows to change the time in the system. The format is 24 hour time, HH:MM. Press Enter to save.
 - 6.18 MONTH:** Use the up / down arrows to change the Month. Press Enter to save.
 - 6.19 DAY OF MONTH:** Use the up / down arrows to change the Day of the Month. Press Enter to save.
 - 6.20 YEAR:** Use the up / down arrows to change the Year. Press Enter to save.

7. CUSTOM CALIBRATION

PRESS SENSOR BUTTON. CAL DATA FROM THE SENSOR WILL RELOAD, THE FOLLOWING WILL BE

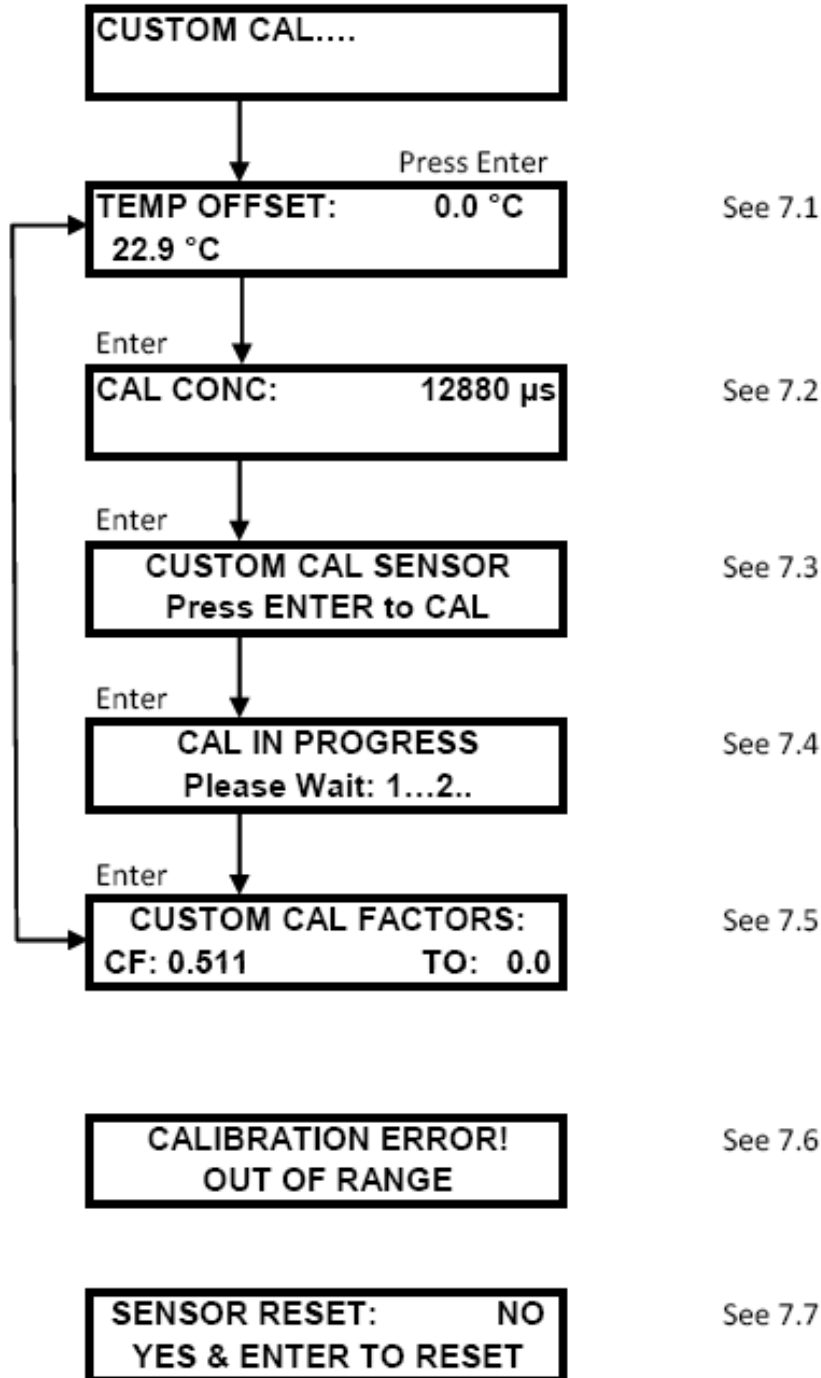

Custom Calibration Menu:

SUMMARY: This menu shows the settings used for performing a custom calibration of a given disposable conductivity sensor. This allows calibration of the unit using an alternative conductivity standard, and a custom temperature offset. After connecting the sensor, press the “Sensor” button, and after reloading the data from the sensor, the “Custom Cal...” screen appears. Press the “Enter” key to enter the Custom Cal menu, use the “Exit” key to bypass it.

- 7.1 TEMPERATURE OFFSET:** The current temperature is displayed in the lower left corner of the screen. Use the Up/Down Arrows to set the desired temperature offset, and press the “Enter” key to select it. Default = **0.0 °C**.
- 7.2 CALIBRATION CONCENTRATION:** Use the Up/Down Arrow keys to set the conductivity value of the custom calibration solution you are using. Press the “Enter” key to select it. Default = **12880 µS**.
- 7.3 CUSTOM CAL SENSOR:** When ready to perform the custom calibration, press the “Enter” key to do the calibration. Press “Exit” to cancel the process.
- 7.4 CAL IN PROGRESS:** This screen is displayed during the calibration, and will count to 10 to complete the custom calibration.
- 7.5 CUSTOM CAL FACTORS:** This screen displays the custom calibration data, the Custom Cal Factor, (CF or CCF) and the Custom Temperature Offset (TO or CTO).
- 7.6 CALIBRATION ERROR! / OUT OF RANGE:** This message will be displayed if the solution is out of range. I. E. a custom calibration at 12880 µS with the sensor in the open air, with a dry sensor has been attempted.
- 7.7 SENSOR RESET:** Used to reset / remove the custom calibration. Press the “Sensor” key to reload the sensor data, and while the custom cal factors are displayed, press the “Enter” key. The Sensor Reset screen will be displayed, and you can change the No to Yes with the Up/Down Arrows, and press the “Enter” key to reset / remove the custom calibration. There is an “Are you sure?” screen that will also need a Yes answer to complete this task.

SciCon Printout Format

RS-232 Output as sent to Serial Printer (Parker p/n 080-095A) or Windows HyperTerminal:

03/12/09; Conductivity v0.38; uS; TEMP REF = 25.00; TEMP COEF = 1.90; ALARMS: HC= 0.0; LC= 0.0; HT= 0.0βC; LT= 0.0βC; Sensor ID=C1-110024-0307; CF= 0.330; TO=0.58; CCF= 1.000; CTO=0.00

RT,	CD,	T,
09:35:00,	2.4,	23.3,
09:35:09,	0.0,	23.3,
09:35:14,	0.0,	23.3,
09:35:19,	0.1,	23.3,
09:35:24,	0.0,	23.3,
09:35:29,	0.0,	23.4,

Abbreviations:

RT = Real Time

T = Temperature, °C

CF = Calibration Factor

TO = Temperature Offset

CCF = Custom Calibration Factor

CTO = Custom Temperature Offset

CD = Conductivity value based on units.

Alarms:

HC = Hi Conductivity

LC = Low Conductivity

HT = Hi Temperature

LT = Low Temperature

Please Note: SciDoc is available to collect this data automatically into an Excel spreadsheet.

Data Collection

Summary: The SciCon has two serial ports. The serial port which is labeled “Pinter / PC,” is used for RS-232 serial communication with a PC or serial printer (Parker P/N 080-095A).

Parker has available a software package, **SciDoc**, that includes an Excel spreadsheet with custom macros that is automatically populated when data is received. It also automatically populates a graph in real time as the data is generated. Discussion of this package begins on the next page.

Alternatively, when a PC is connected to this serial port, all data generated can be sent to the “HyperTerminal” program of a PC. HyperTerminal is ok for viewing the data in real time, but can be a challenge for actually capturing and retrieving the data. The HyperTerminal settings are provided in the section entitled “PC HyperTerminal Settings.”

SciDoc Data Collection Software:

SciDoc a software package that captures the data output of the SciCon and places it in an Excel spreadsheet. This spreadsheet also populates a graph to aid in the analysis of the monitored process. This same spreadsheet will also collect data from Parker's PureTec lab scale TFF system to make it easy to utilize them at the same time.

It consists of a copy of WinWedge32 from TalTech Inc. and a customized spreadsheet with built in macros. It requires the use of a Parker RS-232 cable, P/N 080-073 to connect the SciCon to an available Com Port on the PC. (When used with the PureTec, two Com Ports are required, and Parker has a USB adapter that will provide two Com Ports on one USB connection)

Minimum system requirements are Windows 98, Excel 2000 and WinWedge32 v3.0, which is included in the package.

Once installed, click on the shortcut for the spreadsheet, and the following screen is presented:

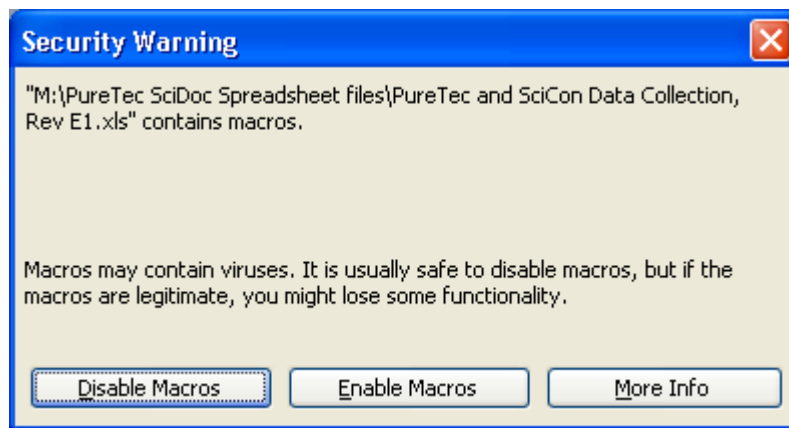

Press "Enable Macros" to begin the process for data collection. If not presented with this screen, the security level of Excel's Macros will need to be adjusted.

Choose Tools – Macros – Security from the Menu Bar, and set the Security level to Medium. Then close and re-open the file, and this option will appear.

Note: If opening a previously saved data set, choose "Disable Macros" instead.

The following screens will be displayed next:

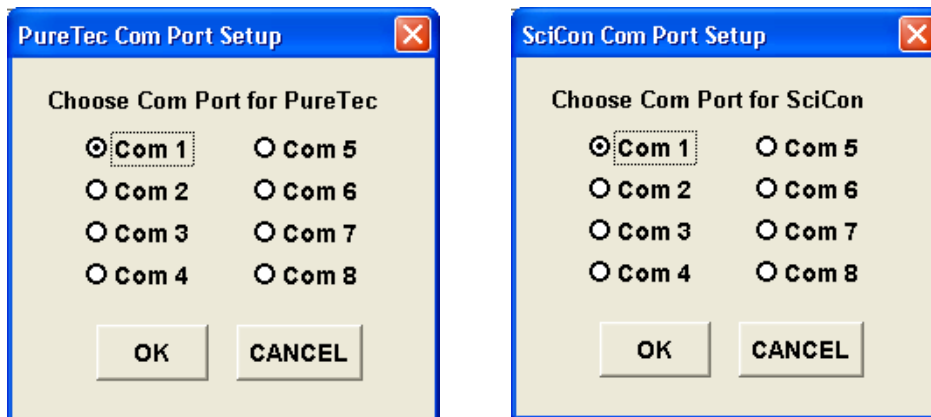

Choose the Com Port the PureTec is connected to on the first one. If not using one, choose “Cancel”. Next choose the Com Port the SciCon is connected to. Click on the OK button and WinWedge32 will start, showing itself as an icon in the system tray. If using both devices, there will be two of these icons.

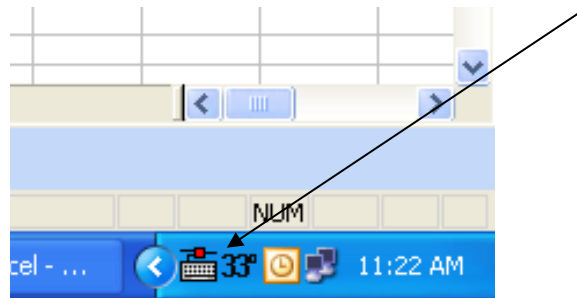

The next screen is then presented:

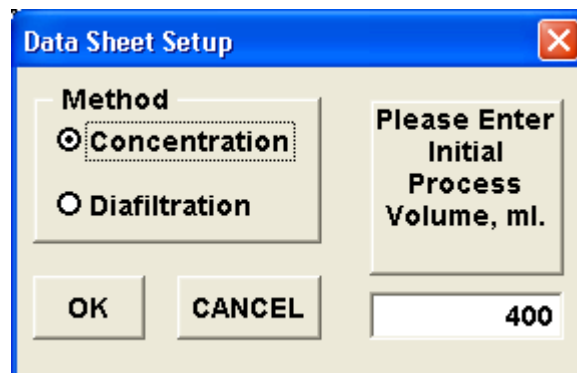

Enter the appropriate data if using a PureTec, otherwise choose “Cancel”. The Operator information screen shown on the next page now appears.

UserForm1

Operator	
Date	
Time	
Product Batch Number	
Product Description	
Conditions	
Membrane Manufacturer	
Membrane Type	
Membrane Lot Number	
Membrane Serial Number	
Membrane Pore Size	
Membrane Surface Area, Square Meters	0.005

OK Cancel

Enter all of the appropriate Operator Information in this dialog box and click on “OK”. Please note: the “Clear Data” button does not affect the information in these fields. Click on the “Operator Info” button on the spreadsheet at anytime to update these fields as needed.

Clicking on “OK” or ‘Cancel” leaves this screen, ready to get started collecting data from the PureTec and SciCon. This is the PureTec tab, the second tab shows the SciCon Data sheet, shown at the top of the next page.

The screenshot shows a Microsoft Excel spreadsheet titled "PureTec and SciCon Data Collection, Rev E1.xls [Read-Only]". The spreadsheet has several tabs: "Com Port Setup", "Data Sheet Setup", and "Operator Info". The "Operator Info" tab is active, showing a table with the following fields and values:

Operator	
Date	
Time	
Product Batch Number	
Product Description	
Conditions	
Membrane Manufacturer	
Membrane Type	
Membrane Lot Number	
Membrane Serial Number	
Membrane Pore Size	
Membrane Surface Area, sq M	0.005

The spreadsheet also shows a table with columns labeled MT, CV, FQ, P1, P2, P3, TM, FF, FP, FR, Y, A1, A2, A3, SY, AL, DP, FLUX, NWP, CF, ET, and CI. The status bar at the bottom indicates "Ready" and "NUM".

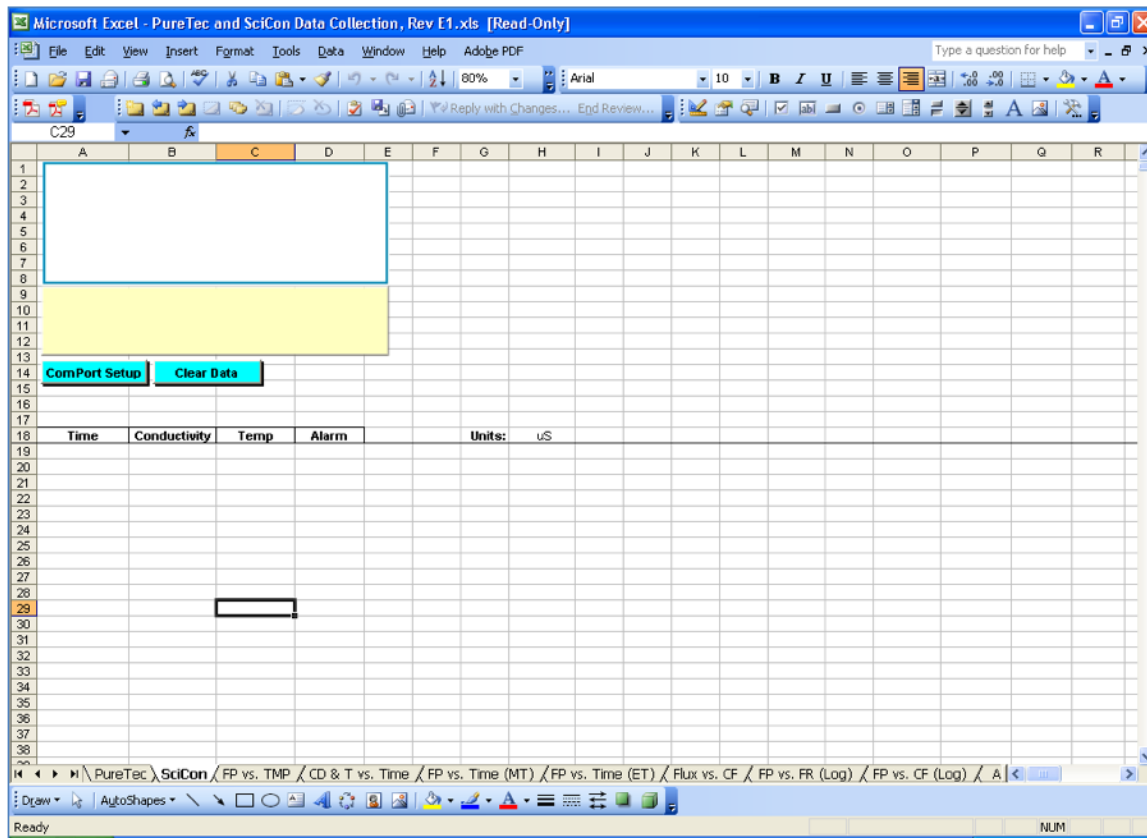

When ready, turn on the SciCon, pressing the “On / Stby” button, or connect the disposable conductivity sensor. The monitor will load the calibration data from the sensor, and place that information in the spread sheet. All remaining data generated will automatically be placed in the cells of the spreadsheet, and the charts populated with the same data. The text box in the upper left of the spreadsheet contains the header information that is generated by the SciCon. This will list the version, the calibration data, all operating parameters, alarm settings and alarm limits.

A chart of Conductivity & Temperature vs. Time has been included, and may be viewed by clicking on the appropriate tab at the bottom of the worksheet.

The end user may, of course, create their own charts or modify those included by adding trend lines, changing titles, etc. While the Data worksheet cells are protected, the charts are not with this purpose in mind.

Click on File-Save as: and choose an appropriate file name based on process run data, etc. When ready for another run, simply press the “Clear Data” button, or close and re-open the file.

Contact Parker Technical Support or your Territory Manager for more information.

PC HyperTerminal Settings:

SciCon to PC: PC communications via the Serial Port labeled “Printer / PC” requires a Parker RS-232 Cable (P/N: 080-073). NOTE: When not using the printer, this allows process data to be “dumped” into a PC for archiving. The list of settings below must match those in Serial section of the SciCon main menu.

The following terminal setting procedure is intended for PCs with a **Windows 95/98/XP** software installation: Press the **START** button in the lower left corner of the screen, select “**All Programs**” then select and open “**Accessories**”, select “**HyperTerminal**”, double-click at the Hyper Terminal icon.

From the “**Connection Description**” screen, select an icon and enter a file name, i.e. SciCon.

Press “Ok”

From the “**Phone Number**” screen, select “**Direct to Com 1**” in the box labeled **Connect Using:** or select any other available Com port.

Press “Ok”

From the “**Com 1 Property**” screen, select the following parameters

Bits per Second:	9600
Data Bits:	8
Parity:	None
Stop Bits:	1
Flow Control:	None

Press “Ok”

All other settings are left at the default values.

Press “Ok” at the bottom of the “SciCon Property – Setting” screen

Appendix A: Sensor Performance Data

8845 South GreenView Dr., Suite 4
Middleton, Wisconsin 53562-2562

Phone: 608.824.0500
Fax: 608.824.0509

www.SciLog.com
SciLog@SciLog.com

SciLog DN 3016 SciCon Conductivity Sensor Sanitization Protocol ⁽¹⁾

Sanitizing Agent ⁽²⁾	Conc.	Temp. ° C	pH	Pressure psi ⁽⁴⁾	Contact Time, Min	Sani-Cycles Limit ⁽³⁾	%SD ⁽⁶⁾ 10 Sani-Cycles
NaOH	0.10 N	20-30	13	0 - 5	15-30	10	0.40%
NaOH	0.50 N	20-30	13	0 - 5	15-30	10	0.40%
NaOCl ⁽⁵⁾	500 ppm	20-30	7 - 8	0 - 5	15-30	10	1.10%
Formaldehyde Solution	1 - 2%	20-30	5 - 8	0 - 5	30	10	0.60%
Isopropyl Alcohol (IPA)	70%	20-30		0 - 5	15-30	10	0.30%

Test Protocol:

Pre-calibrated (12.88mS) SciCon conductivity sensors were exposed to sanitizing solution by pumping the solution through the in-line sensors for 30 minutes, followed by a distilled-water flush. Sensor response recovery was tested by pumping a standard solution of 0.100 M KCl through the sensor and measuring the solution conductivity, nominally 12.88 mS.

Ten, 30-minute sanitization cycles were implemented; 5 hours of total cumulative exposure

Notes:

1. SciCon conductivity sensors have been designed for disposable, single-use applications. However, with proper care, the SciCon sensors can be re-used repeatedly while maintaining good accuracy and precision. If required, the SciCon sensors can be re-calibrated.
2. SciCon sensors can be repeatedly sanitized with any of the listed sanitizing solutions. Do not exceed the recommended number of sanitization cycles. Sensor accuracy and precision will be affected by excessive cleaning / sanitization.
3. Recommended maximum number of cleaning/sanitization cycles.
4. Do not exceed the recommended sanitization pressure range.
5. 1:100 dilution of Clorox Bleach, 500 ppm of active chlorine.
6. Response variance (% standard deviation) of pre-calibrated flow cells over 10 sanitization cycles.

CAUTION: Do Not Exceed Maximum Pressure of 60 psi.

Released 11/15/06, SciLog Metrology, KS

DN 3016 SciCon Sensor Sanitization Summary, 111506KS.xls

SciLog D/N: 3040

Release Date: 01/19/09

Revision: A

Issued By: AWD

Title: SciLog Disposable Sensors, Autoclave Procedure

Objective: The purpose of this procedure is to document the procedure and equipment used for the autoclave testing performed on SciCon, SciPres and SciTemp Sensors.

Equipment used:

Tuttnauer EZ9 Autoclave, (forced air drying, no vacuum).
Brown paper bags, 6.5 x 4.0 x 12.4".
Autoclave Tape (Cole-Parmer P/N 08277-62).

Procedure:

1. Cover the 8 pin cable connector to protect it from moisture using autoclave tape. On SciPres sensors, also cover the ambient pressure hole on the body of the sensor with autoclave tape.
2. Place the sensor into a brown paper bag or other autoclave wrapper and hold it closed with autoclave tape.
3. The following program was implemented on the Autoclave:
 - a. Sterilization Temperature: 257 °F (125 °C)
 - b. Sterilization Time: 30 minutes
 - c. Sterilization Pressure: 18 psi
 - d. Drying Time: 30 minutes (forced air)
4. Allow the sensors to cool for at least one hour at room temperature before returning to use.

All SciLog sensors will survive this autoclave procedure.

For accurate performance, SciLog sensors should not be autoclaved more than two times. Repeated autoclaving will increasingly compromise sensor accuracy.

SciLog DN 3130: SciCon Conductivity Sensor, Post Autoclaving Sensor Response

Objective: Test SciCon Sensor Response after Repeated (4) Autoclave Cycles. Sterilization Conditions: Sterilization Temperature; 257°F (125°C), Sterilization Time: 30 min. Pressure: 19psi, Drying Time: 30 min. Conductivity Test Solution: 12.99mS (KCl)

SciCon, Luer Sensor ID	Pre-Autoclave Response mS	Post Trial 1 Response mS	Post Trial 2 Response mS	Post Trial 3 Response mS	Post Trial 4 Response mS
C1-240061-0208	12.86	12.91	12.94	12.84	12.80
C1-240058-0208	12.96	12.93	12.96	12.67	12.77
C1-240406-0208	12.93	12.99	12.41	12.66	12.60
C1-240059-0208	13.08	13.06	13.09	12.93	13.20
C1-240062-0208	13.02	12.97	13.14	13.01	13.09
Group Average	12.97	12.97	12.91	12.82	12.89
Group SD*	0.08	0.06	0.29	0.16	0.25

* SD = Standard Deviation

Test Protocol: Prior to autoclaving, factory-calibrated SciCon conductivity sensors (5) were removed from inventory and tested against a conductivity solution (12.99 mS) in a temperature equilibrated glove box. The "out-of-box" sensor response data is listed as "Pre-Autoclave" in the table above. The 8-pin sensor connectors were sealed with autoclavable tape (Cole-Parmer P/N: EG-08277-62) The sensors were placed into paper bag (6 1/2"x 4" x12 3/8") and placed in a Tuttnauer EZ9 Autoclave. The following conditions were maintained throughout the four autoclaving trials: 1.Sterilization Temperature: 257°F (125 °C); 2.Sterilization Time: 30 min; 3.Sterilization Pressure: 18 psi, 4.Drying Time 30 min.

After each trial, the SciCon sensors were allowed to cool for one hour inside the temperature controlled (25.0 °C) glove box. 12.99 mS test solution was re-circulated through the five, in-line sensors assembly for 30 min before reading the conductivity values. The SciCon sensor response data (displayed by the SciPres Monitor) is listed in the table above as "Post-Trial 1", "Post-Trial 2", "Post-Trial 3" and "Post Trial 4."

Post-autoclave sensor response tests were carried out with the original factory calibration. No sensor re-calibration were made before, during or after the three trials.

Summary: All SciCon sensors survived the four autoclave trials. However, sensor accuracy becomes increasingly compromised after multiple autoclave cycles. **For accurate performance, SciCon sensors should not be autoclaved more than two times.**

NOTE: SciLog sensors have been designed for disposable, single-use applications. However, with proper care, the sensors can be re-used repeatedly while maintaining good accuracy and precision. If required, sensors can be re-calibrated.

CAUTION: Do Not Exceed Maximum Pressure of 60 psi

Released 5/5/08, SciLog Metrology, KS

DN 3130 SciCon Post Autoclaving Sensor Response KS042508.xls

Confidential



Karl G. Schick, Ph.D.
VP Engineering

SciLog DN 3134: "Out-of-Box" Sensor Performance Test: SciCon Luer

Test Protocol: Eighteen, pre-calibrated conductivity sensors (SciCon Luer) from three different sensor lots were tested to determine "out-of-box" sensor performance. The tests were carried out with a NIST-traceable standard solution (12.88 mS). The sensor conductivity and temperature responses were recorded. The accuracy and precision levels for tested sensors were within established limits. No "out-of-box" sensor failures were found

Lot 1: SciCon Luer Factory Calibrated 10/11/2007			NIST Conductivity mS	Sensor Response mS	NIST Temperature °C	Sensor Response °C
Sensor ID	CF	TO				
C1-230163-1007	0.649	-0.01	12.88	13.06	25.00	24.7
C1-230164-1007	0.625	0.18	12.88	13.02	25.00	24.7
C1-230165-1007	0.637	0.31	12.88	13.08	24.99	24.7
C1-230166-1007	0.625	0.30	12.88	12.90	24.99	24.9
C1-230167-1007	0.634	0.56	12.88	13.02	24.99	24.4
C1-230168-1007	0.627	-0.37	12.88	13.09	24.99	24.4
Group Average	0.633	0.16	12.88	13.03	24.99	24.63
Group SD	0.009	0.32	0.000	0.069	0.000	0.197

Lot 2: SciCon Luer Factory Calibrated 2/29/2008			NIST Conductivity mS	Sensor Response mS	NIST Temperature °C	Sensor Response °C
Sensor ID	CF	TO				
C1-240139-0208	0.602	0.42	12.88	12.74	24.98	25.0
C1-240140-0208	0.630	0.42	12.88	12.90	24.98	24.8
C1-240141-0208	0.622	0.43	12.88	12.71	24.98	25.0
C1-240142-0208	0.615	0.39	12.88	12.71	24.97	24.8
C1-240143-0208	0.611	0.15	12.88	12.88	24.97	24.6
C1-240144-0208	0.630	0.28	12.88	12.78	24.97	24.7
Group Average	0.618	0.35	12.88	12.79	24.98	24.82
Group SD	0.011	0.11	0.000	0.084	0.000	0.160

Lot 3: SciCon Luer Factory Calibrated 5/15/2008			NIST Conductivity mS	Sensor Response mS	NIST Temperature °C	Sensor Response °C
Sensor ID	CF	TO				
C1-240484-0508	0.614	-0.02	12.88	12.90	24.97	24.9
C1-240484-0508	0.631	0.44	12.88	13.00	24.97	24.7
C1-240484-0508	0.614	0.42	12.88	12.94	24.97	24.7
C1-240484-0508	0.620	-0.02	12.88	12.75	24.97	24.7
C1-240484-0508	0.620	0.52	12.88	13.01	24.97	24.7
C1-240484-0508	0.609	0.20	12.88	12.82	24.97	24.6
Group Average	0.618	0.26	12.88	12.90	24.97	24.72
Group SD	0.008	0.24	0.000	0.103	0.000	0.098

Released by SciLog Metrology 1/22/09

SciLog D/N: 3135

Release Date: 04/14/09

Revision: B

Issued By: KGS

Title: SciCon Low Conductivity Accuracy Data

**SciCon Conductivity Sensor: Low Range Accuracy & Precision, 1.9 and 100.3 μS ,
SciCon Monitor Rev. 0.38.**

Test Protocol: Five SciCon Luer sensors were factory calibrated @ 12,88 mS (25°C) and tested with NIST-traceable solutions, 1.92 μS and 100.3 μS (Control Company,Tx) Accuracy and precision levels were determined.

Test Solution			Test Solution				
1.92 μS			100.3 μS				
SciCon			V. 0.38	SciCon			V. 0.38
Conductivity			Factory Cal	Conductivity			Factory Cal
Sensors	Cal	Temp.	@ 12,880 μS	Sensors	Cal	Temp.	@ 12,880 μS
P/N: 080-599	Factor	Offset		P/N: 080-599	Factor	Offset	
Luer Connectors	CF	TO		Luer Connectors	CF	TO	
Sensor ID			Measured Conductivity $\mu\text{S/cm}$	Sensor ID			Measured Conductivity $\mu\text{S/cm}$
C1-210474-0309	0.629	0.40	1.9	C1-210474-0309	0.629	0.40	97.3
C1-210475-0309	0.613	-0.20	2.0	C1-210475-0309	0.613	-0.20	98.3
C1-210476-0309	0.618	0.30	2.0	C1-210476-0309	0.618	0.30	98.4
C1-210479-0309	0.626	0.10	2.0	C1-210479-0309	0.626	0.10	97.6
C1-210490-0309	0.625	0.50	2.0	C1-210490-0309	0.625	0.50	100.5
Average:			1.98	Average:			98.42
SD			0.04	SD			1.25
%SD			2.26%	%SD			1.27%

Released 04/14/09, SciLog Metrology, KGS

© 2015 Parker Hannifin Corporation. All rights reserved.

IOMI-AK1-001_RevA

Parker Hannifin Manufacturing Ltd
Bioscience Division - EMEA
Durham Road
Birtley, Co. Durham
DH3 2SF, England
phone +44 (0)191 4105121
fax +44 (0)191 4105312
email: bioscience.emea@parker.com
www.parker.com/bioprocessing

Parker Hannifin Corporation
Bioscience Division – N.A.
2340 Eastman Avenue
Oxnard, California, USA 93030
toll free: 877 784 2234
phone: +1 805 604 3400
fax: +1 805 604 3401
email: bioscience.na@parker.com
www.parker.com/bioprocessing

